

Energy & Environmental Science

rsc.li/ees

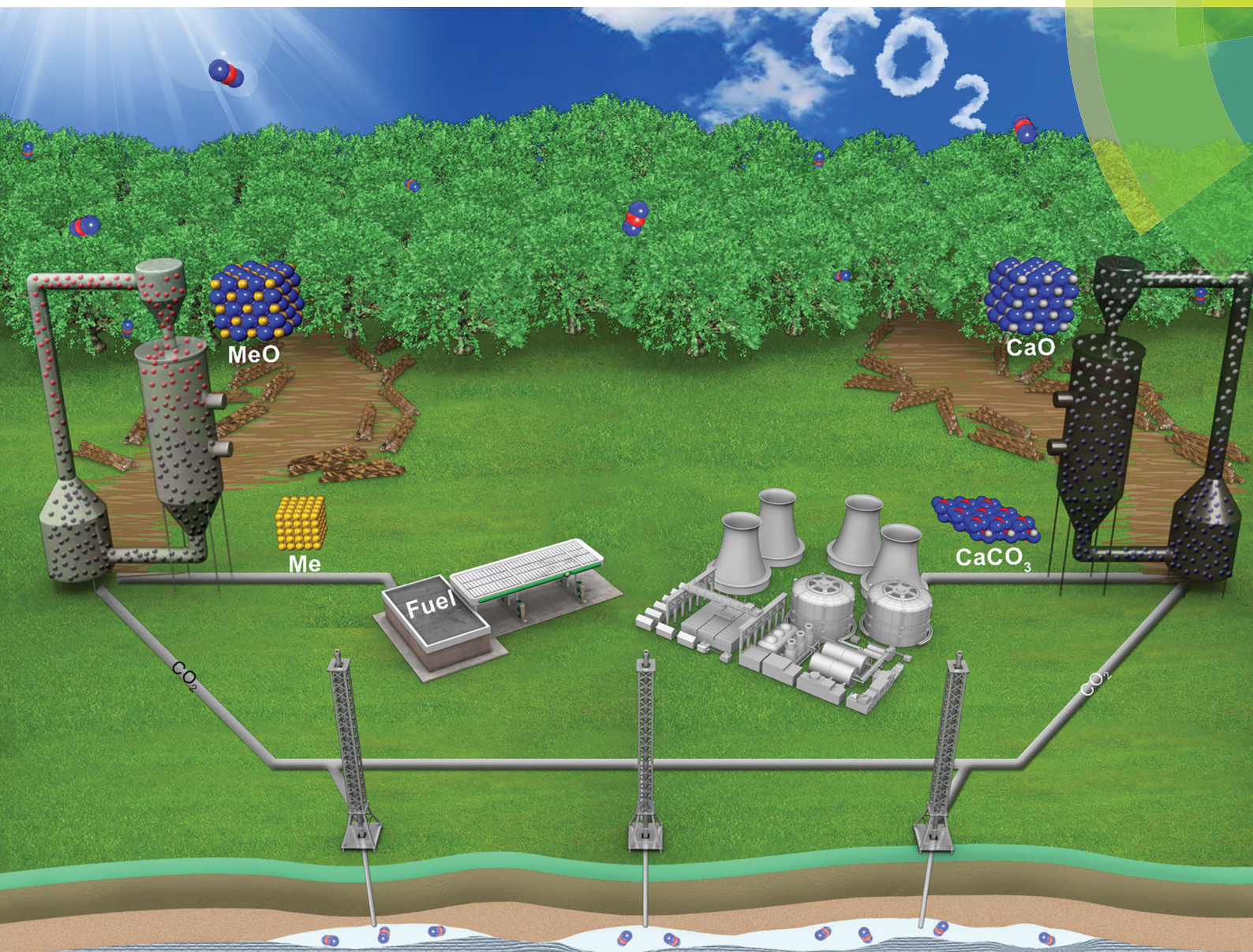

ISSN 1754-5706



ROYAL SOCIETY
OF CHEMISTRY

REVIEW ARTICLE

Ming Zhao, Ah-Hyung A. Park *et al.*

Biomass-based chemical looping technologies: the good, the bad and the future



Cite this: *Energy Environ. Sci.*, 2017, 10, 1885

Biomass-based chemical looping technologies: the good, the bad and the future

Xiao Zhao,^{†ab} Hui Zhou,^{†cd} Vineet Singh Sikarwar,^{ab} Ming Zhao,^{†*ab} Ah-Hyung A. Park,^{†*cd} Paul S. Fennell,^{†e} Laihong Shen^f and Liang-Shih Fan^{†g}

Biomass is a promising renewable energy resource despite its low energy density, high moisture content and complex ash components. The use of biomass in energy production is considered to be approximately carbon neutral, and if it is combined with carbon capture technology, the overall energy conversion may even be negative in terms of net CO₂ emission, which is known as BECCS (bioenergy with carbon capture and storage). The initial development of BECCS technologies often proposes the installation of a CO₂ capture unit downstream of the conventional thermochemical conversion processes, which comprise combustion, pyrolysis or gasification. Although these approaches would benefit from the adaptation of already well developed energy conversion processes and CO₂ capture technologies, they are limited in terms of materials and energy integration as well as systems engineering, which could lead to truly disruptive technologies for BECCS. Recently, a new generation of transformative energy conversion technologies including chemical looping have been developed. In particular, chemical looping employs solid looping materials and it uniquely allows inherent capture of CO₂ during the conversion of fuels. In this review, the benefits, challenges, and prospects of biomass-based chemical looping technologies in various configurations have been discussed in-depth to provide important insight into the development of innovative BECCS technologies based on chemical looping.

Received 21st December 2016,
Accepted 19th May 2017

DOI: 10.1039/c6ee03718f

rsc.li/ees

Broader context

Since carbon in biomass is obtained from atmospheric CO₂, biomass is considered to be a carbon-neutral fuel. By circulating carbon to and from the biosphere through energy generation systems in the form of biomass, issues including climate change can be addressed. Other renewable energy options such as solar and wind can provide carbon-free electricity or even H₂ by splitting water, and thus, they have been rapidly deployed to decarbonise the power sector. However, solar or wind energy cannot directly be used to produce carbon-based fuels and chemicals without additional carbon sources. Considering the ever-increasing need for carbon-based materials (both high density fuels and various chemicals), biomass utilisation is very important towards to allow a decarbonised sustainable future. Chemical looping processes (CLPs) have the advantage that CO₂ is separated *in situ*, thus eliminating the need for an energy intensive CO₂ capture unit. The direct use of solid fuels including biomass in CLPs has a number of difficulties including solid handling and separation challenges, tar formation, and deactivation of looping materials. However, biomass-based chemical looping processes (BCLPs) are important technologies for the future because they start with carbon-neutral fuels. Combined with appropriate CO₂ storage options, BCLPs can allow net negative emissions of carbon.

1. Introduction

The reduction of greenhouse gas (GHG) emissions is one of current society's greatest global challenges. There is a consensus that CO₂ plays a key role in global warming,^{1,2} where the combustion of fossil fuels (coal, petroleum and natural gas) is the greatest contributor to CO₂ emissions.^{3,4} In December, 2015 at the 21st Conference of the Parties of the United Nations Framework Convention on Climate Change (UNFCCC) in Paris, 147 countries set a global aspiration to limit the temperature increase to 1.5 °C above pre-industrial levels.⁵ With the Paris Agreement as a foundation, the world is searching for clean, renewable energy solutions to deal with GHG emissions. Moreover, economic benefits can be expected to be derived from renewable

^a School of Environment, Tsinghua University, Beijing 100084, China.
E-mail: ming.zhao@tsinghua.edu.cn; Tel: +86 10 62784701

^b Key Laboratory for Solid Waste Management and Environment Safety, Ministry of Education of China, Tsinghua University, Beijing 100084, China

^c Department of Chemical Engineering, Columbia University, New York, NY 10027, USA. E-mail: ap2622@columbia.edu

^d Lenfest Center for Sustainable Energy, Columbia University, New York, NY 10027, USA

^e Department of Chemical Engineering, Imperial College London, South Kensington, London, SW7 2AZ, UK

^f Key Laboratory of Energy Thermal Conversion and Control of Ministry of Education, School of Energy and Environment, Southeast University, Nanjing, China

^g William G. Lowrie Department of Chemical and Biomolecular Engineering, The Ohio State University, Columbus, OH 43210, USA

† Equal contributions.

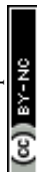

energy resource utilisation in the future, if a greenhouse gas emission trading scheme is established globally. Carbon capture and storage (CCS) is a necessary and viable pathway to reduce global CO₂ emissions and to allow more sustainable use of fossil fuels.^{6,7}

Biomass has a long history as a major energy source and is considered to be an approximately carbon neutral renewable and abundant energy resource. CO₂ is removed from the atmosphere, and solar energy is stored by biomass formation through photosynthesis. This means that using biomass as a fuel does not increase the total atmospheric CO₂ inventory, and when combined with CCS, the overall system becomes carbon negative. Substituting biomass also lessens fossil fuel dependence. Based on the 2011 U.S. Billion-Ton Update, biomass is expected to replace 30% or more of the U.S. petroleum consumption by 2030.⁸ The European Union has outlined the National Renewable Energy Action Plan, which requires utilisation of up to 40% biomass for

electricity, heating and cooling by 2020.⁹ In addition, as argued by the Intergovernmental Panel on Climate Change (IPCC) in its Fifth Assessment Report (AR5, 2013),¹⁰ bioenergy integrated with carbon capture and storage (BECCS) is expected to make a significant contribution to the sustainability of the biomass energy supply.

Modern biomass conversion technologies can typically be classified into biochemical or thermochemical processes. Thus far, biochemical processes are mainly constrained by their low energy efficiency, high water requirement, stringent feedstock property requirements and long conversion times.^{11–13} Conventional thermochemical conversion approaches, including combustion, gasification, and pyrolysis, developed for fossil fuels, can now use biomass feedstocks. Biomass combustion, pyrolysis, and gasification suffer from low efficiency mainly due to the relatively low energy density and high moisture content of biomass.

Chemical looping processes (CLPs) are relatively new and have potential in combustion, gasification and reforming of biomass.

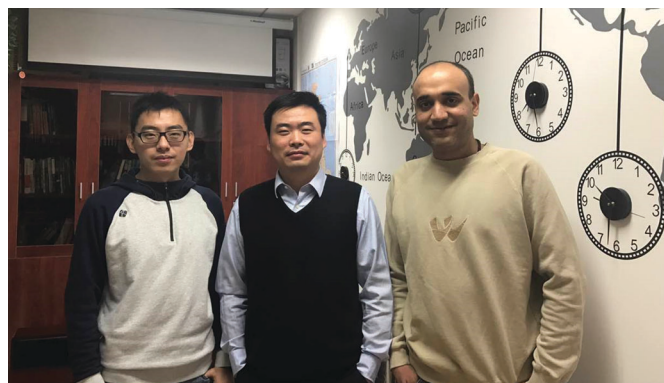

Ming Zhao, Xiao Zhao and Vineet Singh Sikarwar

Ming Zhao (centre), Xiao Zhao (left) and Vineet Singh Sikarwar (right) are from the LBC Group (Laboratory for Biomass Energy & CCUS Technologies) in the School of Environment at Tsinghua University. Dr Ming Zhao is an Associate Professor and the director of the LBC. He obtained his PhD in Chemical Engineering from the University of Sydney in 2010. He was elected to China's Recruitment Program of Global Youth Experts after the completion of his work at Imperial College, London in 2014. Dr Xiao Zhao is currently a postdoctoral research fellow. He entered the LBC after he obtained his PhD in Environmental Engineering from Auburn University in 2015. Vineet Singh Sikarwar is a third-year PhD candidate. He pursued his Bachelor and Master in Mechanical Engineering from Rajiv Gandhi Technical University, India. The research interests of the LBC Group include thermo-chemical conversion of biomass (waste) into clean energy and value-added chemicals, advanced materials and processes for CCUS, and sustainable technologies & management for solid waste. The LBC has been funded by a variety of national grants and also maintains close collaborations with globally-renowned research groups. The LBC Group has published 20+ peer-reviewed articles since its inception in 2015.



Hui Zhou

*Hui Zhou is a postdoctoral research scientist in the Department of Earth and Environmental Engineering and Department of Chemical Engineering at Columbia University. He received his doctoral and bachelor degrees from the Department of Thermal Engineering, Tsinghua University, China, with a minor degree in Computer Science. He won the Outstanding Doctoral Graduate Award and Outstanding Doctoral Thesis Award in 2015. His doctoral thesis entitled *Combustible Solid**

Waste Thermochemical Conversion was published by Springer in 2017. His research interests include the catalytic thermochemical conversion of biomass and municipal solid waste, renewable hydrogen production, and in situ carbon capture.

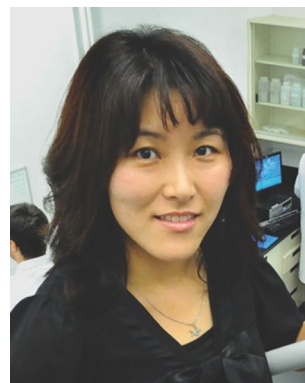

Ah-Hyung A. Park

Alissa Park is a Lenfest Professor in Applied Climate Science of Earth and Environmental Engineering & Chemical Engineering at Columbia University in the City of New York. She is also the Director of the Lenfest Center for Sustainable Energy at the Earth Institute. Her research focuses on sustainable energy and materials conversion pathways with emphasis on integrated Carbon Capture, Utilization and storage including Bio-Energy with Carbon Capture

and Storage (BECCS). Park has received a number of professional awards and honors including the NSF CAREER Award (2009), James Lee Young Investigator Award (2010) and American Chemical Society WCC Rising Star Award (2017).

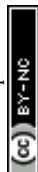

CLPs refer to the cyclic processes carried out as a set of subreactions using looping materials (LMs). During the reaction and regeneration of LMs, reduction–oxidation or carbonation–calcination cycles occur to produce a combination of heat, electricity, fuels and chemicals, as shown in Fig. 1.^{14–16} The concept of chemical looping dates back to the early 1900s for H₂ production using steam-iron reforming.¹⁷ The principles were patented in 1946 for syngas production.¹⁸ The term chemical looping was first introduced in published literature in 1987 by Ishida *et al.*¹⁹ This concept has received intensive application and development since 1997.²⁰

Biomass is an alternative fuel for CLPs, the product of which can be energy/heat or syngas. Additionally, the carbon neutrality of biomass can give more carbon credit for this technology and consequently economic advantages. In the U.S. Department of Energy's road map,¹⁴ CLPs provide the best cost reduction

benefit among the various current and envisioned future technologies of CCS in a carbon-constrained scenario. In 2011, the UK's Energy Technologies Institute commissioned the TESBIC (Techno-economic Study of Biomass to Power with Integrated CO₂ Capture).²¹ This report was completed in 2012, but the results were embargoed for a few years. The study compared 28 different potential combinations of CCS technologies (solvent scrubbing, oxyfuel, Integrated Gasification Combined Cycle (IGCC) and other advanced technologies including chemical looping). The study was unique, in that it combined consultants, industrial, and academic partners to conduct the investigation. Chemical looping was found to be a highly competitive technology, with the lowest potential cost of CO₂ reduction among the technologies considered.

Herein, we review the field of biomass-based CLPs (BCLPs) and its promise to enhance conversion efficiency. Recent publications concerning biomass composition^{22–24} are also reviewed to assist in understanding the behaviour and fate of biomass in CLPs. We then summarise the merits and shortfalls for biomass as a fuel and thoroughly compare the conversion strategies. Previous review articles about CLPs mostly focused on the looping materials,^{16,25–27} operational experience,^{28,29} and/or process design.^{6,20} However, as an emerging significant focus of recent research,^{11,12,15} BCLPs have not been reviewed systematically. Therefore, this article critically approaches the terminologies and results, and concludes by discussing the advantages and disadvantages of the BCLPs technology and how its challenges might be addressed for long-term efficient and sustainable applications.



Paul S. Fennell

Paul Fennell is a professor of Clean Energy at Imperial College London. He obtained his degree in Chemical Engineering and PhD from the University of Cambridge. He chaired the Institution of Chemical Engineers Energy Conversion subject panel (2014–2016), and has acted as an advisor for numerous UK government departments. He is the joint director of IC's Centre for Carbon Capture and Storage and is Deputy Director (CO₂ Capture) for the UK CO₂ Capture and Storage Research Centre. He has published 50+ papers since 2005 and is the 2015 winner of the IChemE Ambassador prize.

Paul Fennell is a professor of Clean Energy at Imperial College London. He obtained his degree in Chemical Engineering and PhD from the University of Cambridge. He chaired the Institution of Chemical Engineers Energy Conversion subject panel (2014–2016), and has acted as an advisor for numerous UK government departments. He is the joint director of IC's Centre for Carbon Capture and Storage and is Deputy Director (CO₂ Capture) for the UK CO₂ Capture and Storage Research Centre. He has published 50+ papers since 2005 and is the 2015 winner of the IChemE Ambassador prize.

2. Biomass as a sustainable fuel

2.1. Biomass characteristics as a fuel and its thermo-physical properties

The definition of biomass has been intensely debated for many years. Broadly, biomass refers to any organic matter available



Laihong Shen

He held a position in the Scientific Committee in the 1st, 2nd and 3rd International Conference on Chemical Looping, and served as the Committee Head (Conference Chair) in the 4th International Conference on Chemical Looping in 2016.

Laihong Shen is a professor of the School of Energy and Environment at Southeast University, China. He obtained his bachelor's degree from Tsinghua University in 1987 and completed his PhD at Southeast University in 1995. Since 2002, his team has been devoted to the development of chemical looping combustion/gasification processes using coal and biomass with regard to the selection of oxygen carrier, reactors design and mechanisms.



Liang-Shih Fan

Member of the Chinese Academy of Engineering, Australian Academy of Technological Sciences and Engineering, and the Mexican Academy of Sciences. He was named in 2008 as one of the "One Hundred Engineers of the Modern Era" by the AIChE.

Liang-Shih Fan is a Distinguished University Professor and C. John Easton Professor in Engineering in the Department of Chemical and Biomolecular Engineering at The Ohio State University. His research interest includes fluidization and multiphase flow, powder technology, and energy and environmental reaction engineering. Professor Fan is a member of the U. S. National Academy of Engineering, an Academician of Academia Sinica and a Foreign



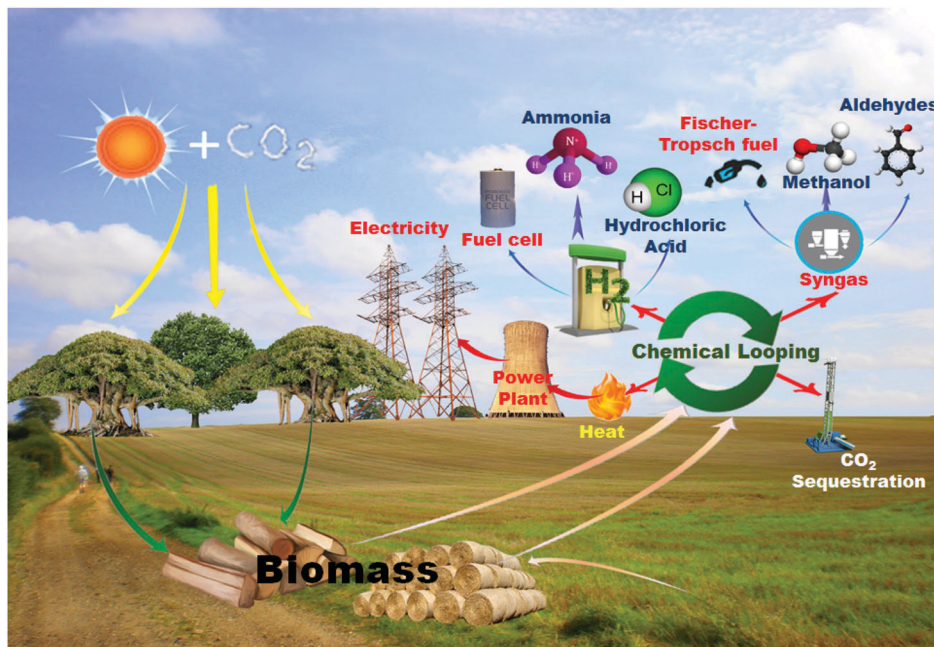

Fig. 1 Chemical looping processes (CLPs) for biomass conversion.

on a renewable basis, including agricultural crops, agricultural waste and residue, wood and wood waste and residue, animal waste, municipal waste, and aquatic plants.^{11,30,31} Gases and liquids recovered from non-fossilised organics are also considered as biomass.³⁰ Primary biomass comes directly from plants, animals or aquatic algae. Secondary biomass is waste produced from primary biomass. Agricultural solid waste, forestry residue, or industrial waste are important sources of biomass waste, along with municipal solid waste such as food scraps, woody waste and paper. Sewage sludge is also biomass since it contains a high proportion of organic matter derived from human excreta, grease and food waste.³⁰ The use of biomass waste therefore not only allows a renewable approach for energy, but is also a potential strategy for recycling municipal solid waste.

The utilisation of biomass is not a new concept. Before the 20th century woody biomass was the major energy source globally.³⁰ However, the low energy density of biomass limited its large-scale applications, especially after fossil fuel use was industrialised. Since fossil fuels are a non-renewable energy resource that contributes to GHG emissions, biomass stands out again as a promising substitute. Biomass is the most abundant solid renewable resource with a global production of up to about 60 EJ per year.³² Woody biomass is still the most commonly used form and it has been estimated that energy derived from wood and woody waste accounts for almost 64% of the total biomass energy.³³

Biomass is a complex mixture of organic and inorganic materials. The main components of organic materials are extractives and fibre or cell wall components, whereas the inorganic material is comprised of ash. Lignocellulosic biomass is believed to be the most promising fuel feedstock and its major constituents are polymeric carbohydrates.³⁴ Although the polymeric compositions of biomass vary widely, they are usually

comprised of three major constituents: cellulose (42–49 wt%), hemicellulose (16–23 wt%) and lignin (21–39 wt%).^{35,36} Cellulose is the skeletal structure of biomass which has the generic formula $(C_6H_{10}O_5)_n$. It is highly polymerised into glucan chains and its inherent bond is glycosidic linkages.³⁷ Hemicellulose is shorter-chained and more amorphous which make it partially soluble in water, whereas lignin is a complex highly branched polymer that holds the cellulose fibres together to provide the mechanical strength of the cell wall.³⁰

Classification of a solid fuel according to its atomic ratio allows correlation of its energy density and heating values. Based on the Van Krevelen diagram for various fuels (Fig. 2a), biomass has relatively higher molar ratios of H/C (1.2–1.8) and O/C (0.4–0.9) among all hydrocarbon fuels, whereas for coal, its H/C molar ratio ranges from 0.3–1.0 and O/C ranges from 0–0.25. The combustion of biomass with high contents of H and O causes high volatile and liquid yields thereby reducing its overall energy conversion efficiency. In addition, fuels with higher H/C ratios have a greater heat of combustion, whereas fuels with higher O/C ratios have higher CO₂ emission per amount of energy release.^{38,39}

Compared to coal, the moisture content of biomass is much higher, which results in a low heating value/energy density for biomass feedstocks. For biomass, lignin usually has lower oxygen content and higher carbon content than cellulose or hemicellulose and it is believed a higher lignin content corresponds to a biomass with a higher heating value.^{12,40} Fig. 2b depicts the effect of moisture and ash content on the effective heating values of various biomass.

The general advantages of using biomass as a fuel include:

- Its renewable nature;
- Close to carbon neutral with negative emission potential;
- Low ignition temperature;



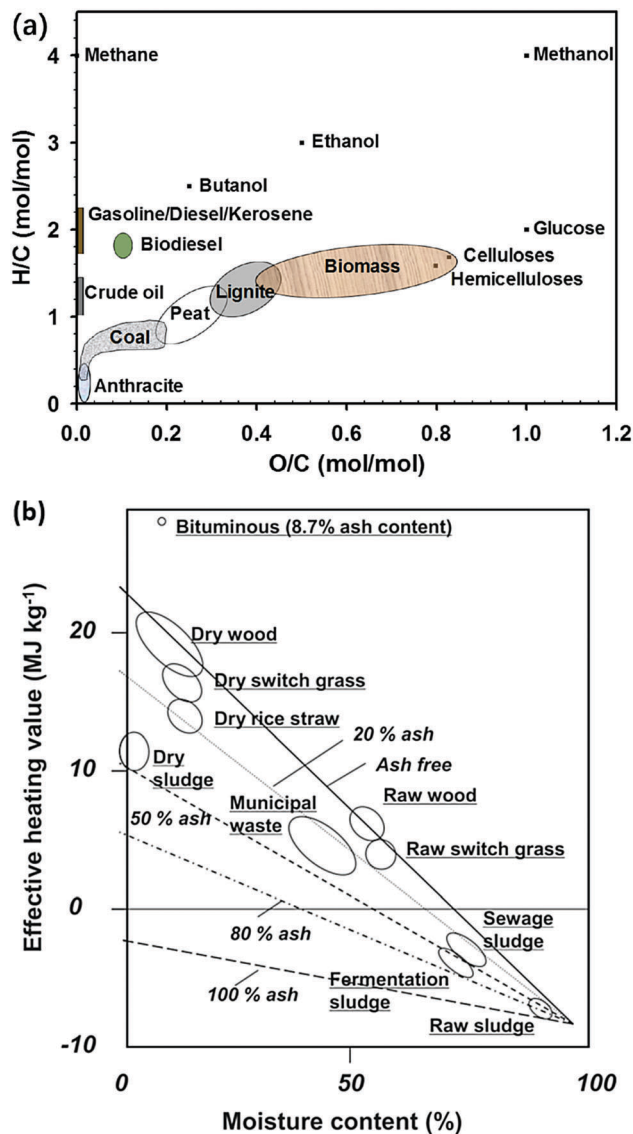

Fig. 2 (a) van Krevelen diagram for various fuels. Adapted from ref. 38 and 39. (b) Effect of moisture and ash content on the effective heating values of various biomass. Adapted from ref. 12.

(d) Generally exceptional low content of pollutants such as sulphur and mercury that are often found in fossil energy sources (*i.e.*, coal); and

(e) Low ash content.

The potential disadvantages of using biomass as a fuel include:

- High moisture content;
- Low energy density;
- Complicated composition and inconsistent feedstock availability;
- High alkaline and alkaline earth metals contents;
- Low ash melting point;
- Uncertainty in collection, transportation and pretreatment costs and

(g) Where a biomass has been grown on degraded or contaminated land, it is possible that it has a significant take-up of heavy metals (in contrast to point (d) in advantages).

Some residual or biomass wastes are favourably used, including (1) non-edible agricultural, forest, feed and food residues; (2) contaminated or industrial biomass; (3) short-rotation energy crops and (4) animal and human waste.⁴⁰ One particular advantage of biomass fuel in comparison to coal for a CLP system is that biomass contains a relatively higher fraction of volatile matter, which will be discussed below.

Biomass ash. The inorganic impurities resulting from biomass-based industrial processes are generally termed ash. Unfortunately, biomass ash is still poorly understood despite the fact that it is one of the most studied characteristics of biomass.^{22,24} Biomass ash composition (Si, Al, Fe, Ca, S, Mg, K, Ti, Na, P, Mn, Cl, and trace elements) is highly variable in nature and is a complex inorganic–organic mixture with solid, liquid and gaseous phases from different origins.²² After examining 86 types of biomass, researchers found that the biomass ash yield (dry basis) ranged from 0.1% to 46% with a mean value of 6.8%.⁴¹ The ash contents approximately followed the decreasing order of: animal biomass > aquatic biomass > contaminated biomass > herbaceous biomass and agriculture biomass > wood and woody biomass. Generally, coal ash yield ranges from 6–52% with a mean percentage of ~21%, therefore compared to coal, biomass is usually considered a low ash content solid fuel.⁴¹ The average heating value decreases in the order of bituminous coal > wood and woody biomass > sub-bituminous coal > contaminated biomass > lignite > herbaceous and agricultural biomass.²²

Vassilev developed a chemical classification of biomass ash, as shown in Fig. 3, examining 86 types of representative biomass and 38 types of solid fuels.²² Three groups of dominant mineral compositions of biomass ash were identified on the basis of their occurrence, content and origin of biomass. As shown in Fig. 3, the upper corner (Si–Al–Fe–Na–Ti) represents mostly glass, silicates and oxyhydroxides, the left corner (Ca–Mg–Mn) includes commonly carbonates, oxyhydroxides and glass, silicates, and the right corner (K–P–S–Cl) is mostly phosphates, sulphates, chlorides glass and some silicates and carbonates.²² Biomass ash can further be divided into four types, S, C, K, and CK. The C, K, and CK types are mainly responsible for the enhanced leaching behaviour, low-temperature transformation, partitioning or emission of volatile components and deposits during combustion. The more acidic S type accounts for enhanced abrasion–erosion during combustion, and the formation of some low-temperature eutectics which decrease combustion efficiency.²²

The different ash compositions of coal and biomass have significant implications for BCLPs, where coal ash has a softening temperature > 1000 °C and a melting point of 1100–1400 °C, which are higher than that most envisaged CLP systems will likely operate.⁴² Biomass ash can melt at significantly lower temperatures (as low as 800 °C), which causes potential issues due to the agglomeration of oxygen carriers.

2.2. Conventional thermochemical conversion of biomass

The current pathways for energy/fuel conversion from biomass can be classified into biochemical and thermochemical processes.^{11,25} Typical biochemical approaches include fermentation, anaerobic digestion and biophotolysis.¹² Biochemical method, in comparison



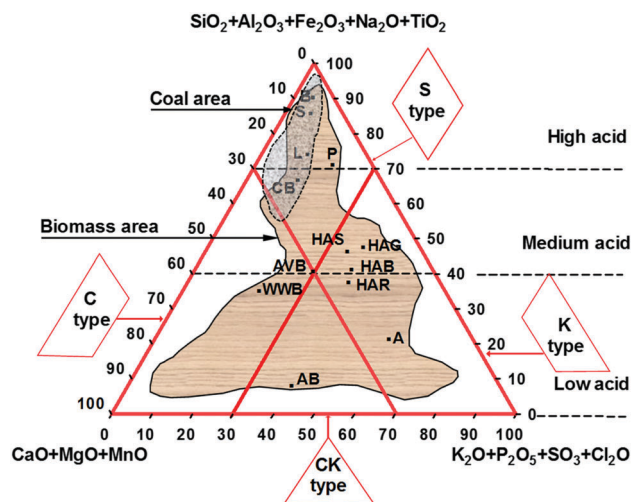

Fig. 3 Chemical classification of ashes and composition areas associated with biomass and coal ash. (Average values: A – algae, B – bituminous coal, S – sub-bituminous coal, L – lignite, P – peat, AB – animal biomass, CB – contaminated biomass, AVB – all varieties of biomass, HAB – herbaceous and agricultural biomass, HAG – herbaceous and agricultural grass, HAS – herbaceous and agricultural straw, HAR – herbaceous and agricultural residue and WWB – wood and woody biomass.) Adapted from ref. 22.

to thermochemical conversion, are potentially more environmentally friendly and less energy intensive; however, they also have very slow kinetics, low energy/fuel conversion efficiency,^{43,44} and more stringent biomass source/property constraints. Moreover, biochemical processes using microorganisms consume a large quantity of water. Furthermore, some cellulosic biomasses are not convertible *via* this route.^{11,45}

Generally, the primary thermochemical processes for biomass conversion include combustion, gasification, pyrolysis and chemical looping. These processes are inherently related to each other. An overall summary of these conversions is tabulated in

Table 1. It should be noted that carbon capture could be added to the back end of the conventional biomass thermochemical conversion processes to capture CO₂ for a net CO₂-negative process. For example, post-combustion carbon capture could be combined with biomass combustion. However, the additional carbon capture unit will increase the complexity of the power plant. In addition, even for the current commercial post-combustion carbon capture technology, the electricity cost will increase by up to 80% and the efficiency of the power plant will decrease by 20–30%.⁴⁶ In comparison, technologies such as biomass-based chemical looping offer higher efficiency and potentially lower cost, and therefore very promising.

2.3. Biomass as a fuel for chemical looping processes

Fuels in various forms can be used as feedstocks for CLPs. Gaseous and solid fuels are the most commonly used forms, whereas very limited studies have been reported on the use of liquid fuels.⁴⁷ With gaseous fuels, solid LMs can react directly with the fuel through intensive gas–solid interactions resulting in high conversion efficiency, whereas with the use solid fuels, the direct solid–solid interactions between LMs and solid fuels are extremely slow and solid LMs can only react with the released volatiles or gasified components.

Methane/natural gas is the most studied fuel for CLPs and its predominant reactions are heterogeneous gas–solid reactions between fuel and oxygen carriers (OCs). When fuelled by coal, the chemical reactions involved are (gaseous phase mediated) heterogeneous solid–solid reactions, which can be extremely slow. The reported coal conversion and CO₂ concentration in the fuel reactor are significantly lower than that in gas-fuelled chemical looping combustion (CLC) systems.^{11,52,53} Due to the relatively low reactivity of coal, the development of solid fuel use for chemical looping processes has been stagnant for some time.⁵⁴

As a renewable energy resource, biomass can act as a potential alternative to fossil fuels. Moreover, the key advantages of

Table 1 Comparison of the major thermochemical conversion processes^{12,22,30,44,45}

Thermochemical conversion	Combustion	Gasification	Pyrolysis
Purpose	Converting biomass to heat and electricity	Converting biomass to high HV gas	Converting biomass to biochar and bio-oil
Atmosphere	Oxidizing atmosphere (oxidant usually higher than the stoichiometric value)	Partial oxidizing atmosphere (oxidant lower than the stoichiometric value)	No oxidant
Reaction medium	Air	Air, pure oxygen, steam, and CO ₂	None
Temperature	700–1400 °C	500–1300 °C	380–830 °C
Gas products	CO ₂ and H ₂ O	CO, H ₂ , CO ₂ , H ₂ O, and CH ₄	CO, H ₂ , CH ₄ and other hydrocarbons
Pollutants	SO _x , NO _x , polycyclic aromatic hydrocarbons (PAHs), and dust	H ₂ S, NH ₃ , tar, and dust	H ₂ S, NH ₃ , tar, and dust
Advantages	Process is relatively simple. Co-combustion of biomass and coal do not need changes to current power plants.	Production of a variety of chemical products, such as methanol and other hydrocarbons, allows for flexible adaptation to market conditions.	Liquid fuels are directly produced, which after appropriate treatment may be directly treated in conventional refineries.
Disadvantages	NO _x , SO _x , and particulates are formed during combustion. ⁴⁸ Other potential unburnt pollutants, such as CO, PAHs, condensed fumes (tars/oils), soot, and unburnt carbon also have negative environmental implications. ⁴⁹ Elements including Si, K, Na, S, Cl, P, Ca, Mg, and Fe present in biomass can cause ash fouling and slagging (ash fusion). ⁵⁰	Tar can block downstream processes and lower gasification efficiency. ⁵¹	High energy consumption is inevitable for pyrolysis due to its endothermic nature, and further research is needed before its industrial scale implementation. ¹²



Table 2 Comparison of the chemical looping processes using various feedstocks

	Gaseous fuel	Solid fuels	
	Natural gas	Coal	Biomass
Net CO ₂ effect w/o CCS	Carbon positive	Carbon positive	Nearly carbon neutral
Net CO ₂ effect w/ CCS	Carbon neutral	Carbon neutral	Carbon negative (BECCS)
Fuel reactivity	High	Low	High
Gasification temperature	Not applicable	High	Low
Interactions between fuel and looping materials	Direct solid–gas interactions	Direct solid–solid interactions (extremely slow); Volatiles or gasified components for solid–gas interactions.	Direct solid–solid interactions (extremely slow); Volatiles or gasified components for solid–gas interactions.
Fuel-LMs contact efficiency	High	Low	Low
Solid circulation rate	Low	High	High
Influence of fuel-derived sulphur on LMs	Low	High	Low
Influence of fuel-derived alkaline/earth alkaline metals on LMs	No	Low	High
Influence of tar on the system	No	Low	High
Influence of ash melting on the system	No	Low	High
Separation of ash and looping materials	Unnecessary	Necessary	Necessary
Pre-drying of fuel	Unnecessary	Unnecessary	Depends on biomass moisture content and CLPs types

biomass in comparison to coal in CLC systems include its greater overall reactivity, its char allows more rapid complete burnout, and lower potential for transfer of carbonaceous material to the metal/air reactor, where it would burn and release CO₂.⁴² Some other aspects associated with CLPs for various forms of fuels are summarized in Table 2.

3. Innovative schemes of biomass-based chemical looping technologies

Compared to other CCS technologies, CLPs can achieve higher energy efficiency due to their inherent avoidance of gas separation steps. Early research on CLPs mainly focused on gaseous fuels, while CLPs based on solid fuels experienced important developments in the last decade.²⁹ In addition, biomass-based CLPs, *i.e.* BCLPs, are attracting growing interest as an effective approach to realise BECCS. Moreover, if biomass waste (such as sludge from wastewater treatment plants) can be utilised to produce energy, BCLPs can provide a route for waste to energy.

In any system, the maximum amount of usable work during a transformation to equilibrium with regards to a chosen reference state is called exergy.^{14,55} CLP is an emerging technology, which has the dual advantages of minimising exergy loss and simplifying product separation. As shown in Fig. 4a, in a typical CLP, the overall reaction (eqn (1)) can be divided into two sub-reactions (eqn (2) and (3)) occurring in two separate reactors. The looping material in the form of LM1 is transformed into LM2 after reacting with A (eqn (2)) followed by the regeneration of LM2 in the other reactor (eqn (3)) making a closed loop with the interlinked reactors. Moreover, the products of eqn (1), C and D, are separated in two sub-reactions. It is noteworthy that when using a solid LM, the CLP is predominantly a series of gas/solid reactions or even (gas mediated) solid/solid reactions.

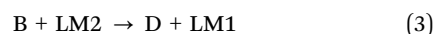
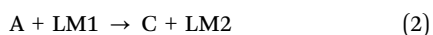

Similar to CLPs, BCLPs can also be classified on the basis of LMs, *i.e.* oxygen carrier, OC, and CO₂ carrier, CC (Fig. 4b).¹⁴ OC can transfer O by providing lattice oxygen in the processes of biomass-based chemical looping combustion (BCLC) and biomass-based chemical looping gasification (BCLG) or releasing molecular oxygen in the processes of oxygen uncoupling-BCLC (OU-BCLC) and oxygen uncoupling-BCLG (OU-BCLG). When CO₂ carriers serve as LMs, biomass gasification is enhanced by a recyclable CO₂ acceptor, which is usually CaO. Taking advantage of the typical calcium looping (CaL), *in situ* carbon capture can be realised in the gasifier and a CO₂-rich stream can be produced in the calciner/regenerator. Similarly, the process mainly producing heat can be termed biomass calcium looping combustion (BCaLC), whereas the process mainly producing gas is termed biomass calcium looping gasification (BCaLG).

The BCLPs can also be categorized based on the target output as follows:

(a) To generate heat/electricity. This type of process refers to combustion, as shown in Fig. 5a (BCLC) and Fig. 5d (BCaLC);

(b) To generate fuels such as H₂ or syngas. This type is usually referred to as a gasification or reforming process, as illustrated in Fig. 5b (BCLG) and Fig. 5e (BCaLG).

(c) To co-generate heat and gas. When the fully reduced OCs from the fuel reactor are oxidised successively by H₂O and air, H₂ and heat could be generated, respectively. Such technology combines the production of electricity and fuels, and is thus referred to as biomass-based co-production chemical looping process (BCCLP), as shown in Fig. 5c.

Moreover, OCs and CCs can co-exist in one system with dual loops, as shown in Fig. 5f, which is usually termed as sorption-enhanced BCLG (SE-BCLG).

3.1. Biomass-based chemical looping combustion (BCLC)

BCLC processes can convert biomass and produce a pure stream of CO₂. In a typical BCLC process, a metal oxide (Me_xO_y) and its



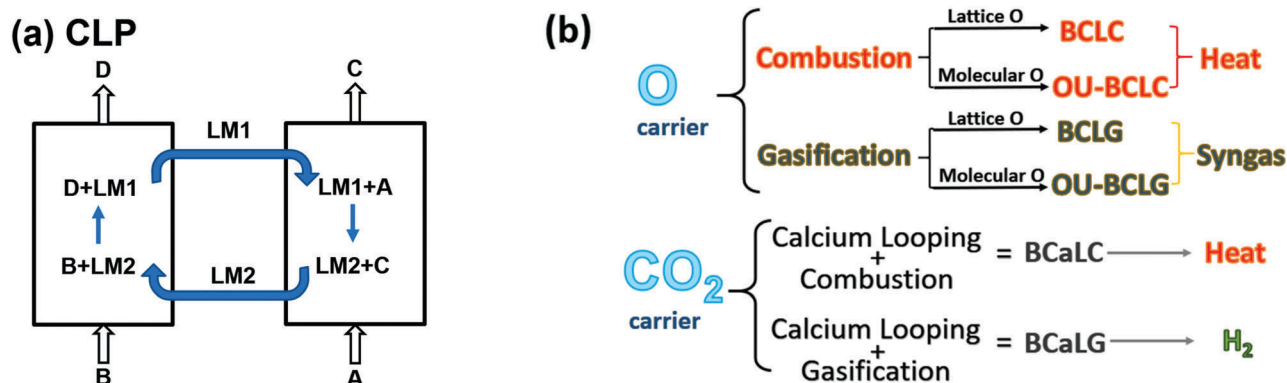

Fig. 4 (a) Schematic principles of chemical looping, and (b) classification basis for typical biomass-based CLPs.

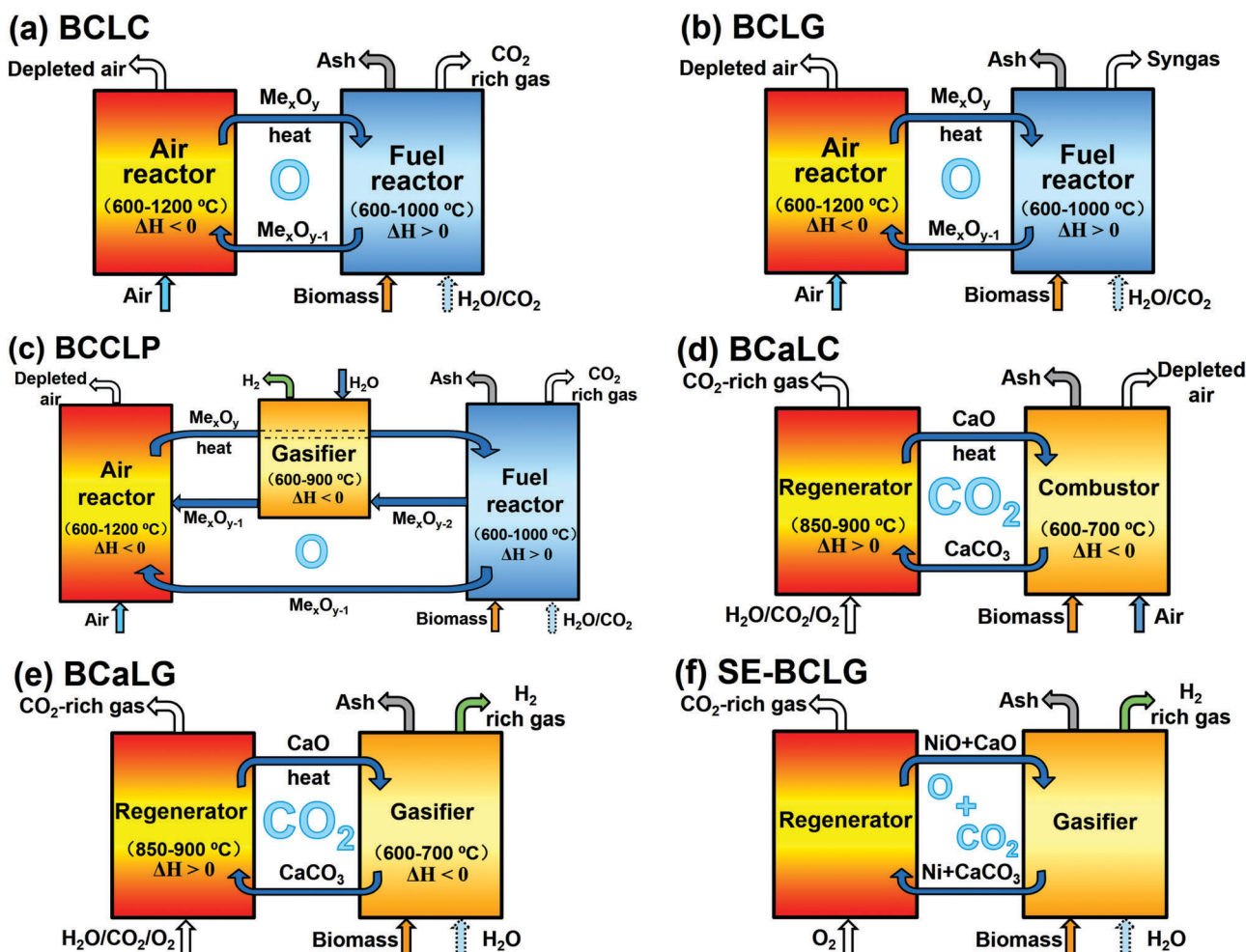
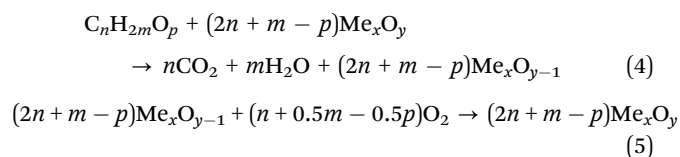
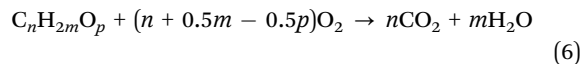

Fig. 5 Schematic principles of (a) biomass-based chemical looping combustion (BCLC), (b) biomass-based chemical looping gasification (BCLG), (c) biomass-based co-production chemical looping process (BCCLP), (d) biomass-based calcium looping combustion (BCaLC), (e) biomass-based calcium looping gasification (BCaLG) and (f) sorption-enhanced BCLG.

reduced form ($\text{Me}_x\text{O}_{y-1}$) serve as an OC, which transports oxygen between the air reactor (or oxidiser) and fuel reactor (or reducer), as shown in Fig. 5a. In the fuel reactor, Me_xO_y reacts with biomass ($\text{C}_n\text{H}_{2m}\text{O}_p$) to produce CO_2 , H_2O and $\text{Me}_x\text{O}_{y-1}$ (eqn (4)), whereas in the air reactor, $\text{Me}_x\text{O}_{y-1}$ is oxidised, as illustrated in eqn (5).



Usually (with some exceptions), the reactions based on eqn (4) are endothermic and the reactions based on eqn (5) are exothermic. The net energy balance of the whole system for an ordinary combustion system, combining eqn (1) and (2), can yield a complete ordinary combustion (eqn (6)):



In the BCLC route, the OC is the key material that circulates within the two reactors thus avoiding direct contact between the fuel and air. Almost pure CO_2 , which can be readily captured, is obtained from the fuel reactor. Moreover, compared to the traditional combustion processes, BCLC can greatly reduce NO_x emissions and enhance thermal efficiency.⁵⁴

There are two approaches to realise BCLC: (1) gasify biomass to form syngas and then use it for CLC. However, an additional gasifier is required (both increasing Capex significantly and leading to unfavourable economics^{56,57}) to produce undiluted syngas. (2) Directly introduce biomass into the fuel reactor. Sometimes, biomass is gasified *in situ* by H_2O or CO_2 as the gasification agent, which is termed *in situ* gasification BCLC (*iG*-BCLC), as shown in Fig. 6a. Two reaction paths are proposed between the OC and biomass in the fuel reactor: (a) direct reduction of OC by biomass, and (b) reduction of OC by the gaseous biomass gasification product. The first path has two components, reactions of the volatile matter ejected from the fuel with the OC and direct solid–solid reactions. The relatively high volatile matter composition of biomass and high reactivity of biomass tar in comparison to high-rank coals yield an advantage for biomass in this context in that a greater proportion of the fuel can directly reduce the oxygen carrier in a CLC system, as opposed to reacting indirectly through an intermediate gas-phase species such as CO or H_2 . Solid–solid reactions are generally limited, owing to the low solid/solid contact efficiency and are usually considered unlikely to occur at an appreciable rate.⁵⁷ In the second path, biomass is gasified with H_2O/CO_2 to yield mainly H_2/CO , and the produced syngas can readily react with the OC. In this study, BCLC refers to *iG*-BCLC if there is no specific reference.

The direct use of biomass as a fuel has been extensively investigated. Key information comparing the representative cases of BCLCs is summarised in Table 3. In a 1.5 kW_{th} process (case ICB-2013), pine sawdust was used as a fuel and iron ore was used as the OC.⁵⁸ Small amounts of CO, H_2 and CH_4 were detected as unburned compounds. Tar (mostly naphthalene) production was reported to decrease at high fuel reactor temperatures. Carbon capture efficiencies (> 97.5%) were obtained in the temperature range of 880–915 °C using either steam or CO_2 as the gasifying agent.⁵⁸ Also in the case of SEU-2009, synthesised iron oxides were used with pine sawdust in a 10 kW_{th} process.⁵³ Higher fuel reactor temperatures led to a greater increase in CO production than the consumption of CO in the oxidation to CO_2 alone. The reduction of Fe_2O_3 to Fe_3O_4 was utilised for iron oxide reduction with biomass syngas.⁵³ More recently, in cases SEU-2015a and 2015b, dewatered sewage sludge was investigated for CLC^{59,60} using Fe-based or Ni-based OCs. Increasing the fuel

(a) *iG*-BCLC

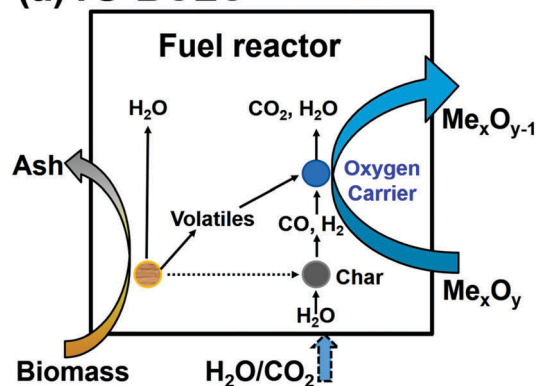

(b) OU-BCLC

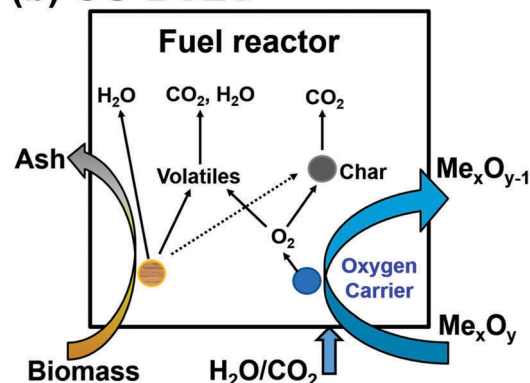

Fig. 6 Main reactions in the fuel reactor for solid fuels: (a) *iG*-BCLC (referred to as BCLC in this article) and (b) OU-BCLC.

reactor temperature intensified the gasification step and the subsequent reduction process, thus increasing the carbon conversion and combustion efficiency. Over 10 h of continuous operation the reactivity of hematite only slightly decreased, which illustrates that CLC could be an alternative treatment technology for sewage sludge. BCLC can also be integrated with torrefaction processes using produced volatiles as feedstock with high energy conversion efficiency for the overall processes reported.^{61,62} In this way, biomass is indirectly utilised and thus will not be discussed in detail in this review.

Carbon capture efficiency (η_{cc}) represents the removal efficiency of carbonaceous gas that would otherwise be emitted to the atmosphere. This parameter is calculated as the ratio of carbonaceous gas flow leaving the fuel reactor to overall carbonaceous gas outlet stream of CLCs:⁵⁸

$$\eta_{cc} = \frac{[F_{CO_2,FR} + F_{CO,FR} + F_{CH_4,FR}]_{out} - [F_{CO_2,FR}]_{in}}{[F_{CO_2,FR} + F_{CO,FR} + F_{CH_4,FR} + F_{CO_2,AR}]_{out} - [F_{CO_2,FR}]_{in}} \quad (7)$$

where, $F_{i,FR}$ is the *i* species molar flow in the fuel reactor inlet/outlet stream. When CO_2 is used as the fluidisation agent, the inlet CO_2 flow must be subtracted. $F_{CO_2,AR}$ is the CO_2 gas flow at the air reactor outlet. Thereby, the carbon capture of the whole process can be calculated.



Table 3 Summary of key information for BCLC and OU-BCLC^a

Case no. (size)	Biomass	Oxygen carrier	Fuel reactor	Air reactor	Efficiency and remarks
CUT-2013 (12 MW _{th}) ^{68,69}	Wood chips (Ash: 26% Ca, 12% K, 4% Mg, 2% Si, etc.)	Nature ore ilmenite (mainly FeTiO ₃)	Circulating fluidised boiler with oxidation/redox cycle within the main boiler.		<ul style="list-style-type: none"> Operational time: 96 h. As compared with the blank case, up to 30% NO reduction was observed when 40% ilmenite was introduced as an oxygen carrier. Potassium was found to be the key problematic ash compound. Homogeneously diffused potassium was observed with KTi₃O₁₆ formed.
ICB-2013 (1.5 kW _{th}) ⁵⁸	Pine sawdust (Ash: 41% CaO, 9% K ₂ O, 7% MgO, 7% SiO ₂)	Iron ore (76% as Fe ₂ O ₃)	Bubbling fluidised bed, fluidised by steam or CO ₂ . Operation temperature: 880–915 °C	Fluidised bed, fluidised by nitrogen.	<ul style="list-style-type: none"> Operational time: 78 h. A small quantity of CO, H₂ and CH₄ was detected as unburned compounds. Tar content decreased at high fuel reactor temperatures. Carbon capture efficiencies of more than 97.5% were obtained in 880–915 °C both using steam and CO₂ as gasifying agents.
SEU-2009 (10 kW _{th}) ⁵³	Pine sawdust	Iron oxide (mainly Fe ₂ O ₃)	Spout-fluidised bed. Operated at 740–920 °C. Fluidising agent: CO ₂ . Operation temperature: 740–920 °C	Fast fluidised bed	<ul style="list-style-type: none"> Operational time: 30 h. Higher temperatures in the fuel reactor helped to increase CO production from biomass gasification. The transformation of Fe₂O₃ to Fe₃O₄ is the favoured step in the process of iron oxide reduction with biomass syngas.
SEU-2011 (1 kW _{th}) ⁷⁰	Sawdust	Natural iron ore (81% as Fe ₂ O ₃ and 15% as SiO ₂)	Spout-fluid bed-rectangular bed. Fluidised with steam and N ₂ . Operation temperature: 740–925 °C	High-velocity fluidised bed.	<ul style="list-style-type: none"> CO₂ capture efficiency: 95.25% at 720 °C and ~98.6% at 925 °C. At a higher fuel reactor temperature, a lower CO₂ concentration was produced. The poor oxygen transport capacity and the thermodynamic constraint of the iron ore limited the conversion efficiency of carbonaceous gases.
SEU-2015a ⁶⁰	De-watered sewage sludge (Ash: 31% Si, 16% Al, 14% P, 17% Fe, 11% Ca, etc.)	Ni-based material (20% NiO, 39% NiAl ₂ O ₄ and 41% Al ₂ O ₃)	Batch fluidised bed reactor. Fluidised with steam and N ₂ . Operation temperature: 700–900 °C.	Batch fluidised bed reactor.	<ul style="list-style-type: none"> The nickel-based oxygen carrier enhanced the overall carbon conversion and fuel conversion rate. When compared to bituminous coal as the feedstock, a higher carbon conversion and fuel conversion rate were obtained for sewage sludge (at 700–900 °C). Lower CO₂ capture efficiency was reported (75–84%) for sewage sludge than coal (around 82–92%). No sintering/agglomeration issues were reported during 20 redox cycles.
SEU-2015b (1 kW _{th}) ⁵⁹	De-watered sewage sludge (Ash: 36% Si, 20% Fe, 15% Al, 11% P, etc.)	Hematite (83% as Fe ₂ O ₃)	Spout-fluid bed reactor. Fluidised with steam. Operation temperature: 800–925 °C.	Fast fluidised bed	<ul style="list-style-type: none"> Operational time: 10 h. Increasing the fuel reactor temperature intensified the gasification step and the subsequent reduction process leading to an increase of carbon conversion and combustion efficiency. During 10 h continuous operation, hematite showed a slight decrease in reactivity.
ICB-2014 (1.5 kW _{th}) ^{66,67}	Pine wood chips. (Ash: 41% CaO, 9% K ₂ O, 7% MgO, 7% SiO ₂)	Cu-based material, prepared <i>via</i> spray-drying using CuO and MgAl ₂ O ₄ .	Bubbling fluidised bed. Fluidising agent: N ₂ and CO ₂ . Operation temperature: 860–935 °C.	Bubbling fluidised bed	<ul style="list-style-type: none"> Operational time: 10 h. A fuel reactor temperature higher than 900 °C was required to exploit the oxygen uncoupling benefits, resulting in no unburnt compounds at the fuel reactor outlet. The char conversion rate of biomass in the CLOU process was between 3 and 4 times higher than that corresponding to the iG-CLC process at temperatures above 900 °C.

^a Case no: CUT: Chalmers University of Technology, Sweden; SEU: Southeast University, China and ICB: Instituto de Carboquímica (ICB), Spain.

Research groups from Southeast University (SEU, China) and Instituto de Carboquímica (ICB, Spain) adopted this parameter to compare the carbon negativity of the BCLC processes. The reported η_{cc} is summarised in Fig. 7 as a function of the working temperature of the fuel reactor.

As shown in Fig. 7, all the η_{cc} are higher than 95% for cases SEU-2011, 2015b and ICB-2013. The η_{cc} increased at a higher temperature for all three cases. It is noteworthy that dewatered sewage sludge was used as biomass feedstock in SEU-2015b and the η_{cc} reached almost 100% at 800–900 °C, which indicates that no char bypassed to the air reactor.⁵⁹ For case SEU-2015a, which

was also sewage-sludge-based, the efficiency oscillated between 75% and 84%. The different reactor designs, OCs used, and ash properties may contribute to this discrepancy.

Tar. In the fuel reactor, besides the high yields of volatiles, tar is produced during woody biomass gasification. The introduction of a catalyst can effectively reduce the tar content, for example in case ICB-2013, the reduction percentage of tar content was observed to be 2.4% per degree Celsius with the addition of iron ore.⁵⁸ Higher operational temperatures in the fuel reactor can also help to reduce the tar content in the product gas.



Primary, secondary and tertiary tars can be produced during biomass pyrolysis and this tar classification is also applicable for BCLP studies.⁶³ Primary tars are mainly cellulose, hemicellulose or lignin-derived products. Secondary tars are characterised by olefins and phenolics whereas tertiary tars are comprised of methyl derivatives of aromatics (methyl-naphthalene, toluene, indene and phenol) and polycyclic aromatic hydrocarbons (PAHs) without substituents (benzene, naphthalene, anthracene, phenanthrene and pyrene). With elevated temperatures, the produced tars can be converted into light hydrocarbons thereby shifting from primary or secondary tars to tertiary tars. Heavier tars are more difficult to gasify, even at high temperatures. Less styrene, indene and naphthalene were found to be produced at higher operation temperatures, which indicate higher reforming and catalytic reactivity at higher temperatures.⁵⁸

Gasifying agent. The CO₂ stream from the air reactor can be recirculated to the fuel reactor as the gasifying agent to save on the cost of steam generation. When coal is used as a feedstock in CLC, the use of CO₂ in the gasifying mixture is limited owing to the poor carbon capture efficiency. The gasification efficiency of char is lower for CO₂ than steam under identical conditions.^{58,64} However, the performance of pine sawdust is less dependent on the gasifying agent, where no significant changes in overall efficiency or tar cracking were observed when changing from steam to CO₂.⁵⁸ Therefore, there may be a significant advantage to use dry recirculated CO₂ as a gasifying agent in the fuel reactor of BCLC.

OU-BCLC. For solid fuels, another milestone achieved is the development of chemical looping oxygen uncoupling (CLOU) by Lyngfelt and researchers from Chalmers University of Technology (Gothenburg, Sweden).^{57,65} Instead of using lattice oxygen in the OCs (Fig. 6a), the molecular O₂ released from the OCs was used as the key oxidant in the fuel reactor (Fig. 6b). CLOU can also be categorised as oxygen uncoupling-CLC (full oxidation) and oxygen uncoupling-CLG (partial oxidation). In a typical OU-BCLC system,

as depicted in Fig. 6b, biomass can be devolatilised in the fuel reactor to produce volatile matter and a carbonaceous solid residue (mainly char). At the same time, the OC can release molecular O₂, enabling the combustion of volatiles and char (eqn (9)–(11)).

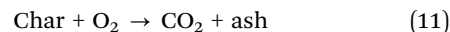
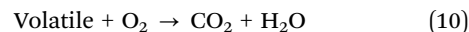
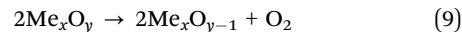
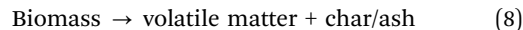

Similarly, in *i*G-BCLC, after steam condensation, pure CO₂ can be obtained from the exit gas of the fuel reactor. The processes of OU-BCLC and *i*G-BCLC share some similar difficulties, including separation of OCs from residue solids, carbon deposition and OCs deactivation. Moreover, only a limited number of metal oxides can meet the requirement for multiple cycles of oxygen uncoupling processes.²⁷

OU-BCLC is a relatively new concept and to the best of our knowledge, only a few related studies are available, in which OU-CLC was mostly performed with coal. In case ICB-2014 (last entry of Table 3), pine wood chips with a heating value of 19.2 Mg kg⁻¹ were used in a CuO OU-BCLC,⁶⁶ and higher temperatures improved the oxygen uncoupling effect (as expected by thermodynamics). A fuel reactor temperature > 900 °C resulted in O₂ production and no unburnt compounds at the fuel reactor outlet. The biomass char conversion rates were around 3 to 4 times higher than the corresponding *i*G-BCLC processes at > 900 °C.⁶⁶ In the comparison of *i*G-BCLC and OU-BCLC in a continuous 1.5 kW_{th} BCLC unit, the OU-BCLC technology presented the advantage of less tar at the outlet of fuel reactor.⁶⁷ Meanwhile, OU-BCLC generated a lower quantity of unburned products, such as H₂, CO, and CH₄, which decreased with an increase in temperature, as shown in Fig. 8.

3.2. Biomass-based chemical looping gasification (BCLG)

BCLG shares similar principles with BCLC, as illustrated in Fig. 5b.⁶ However, in contrast to BCLC, BCLG can produce useful combustible gas. Biomass is partially oxidised (to produce a mixture of H₂ and CO, syngas) as opposed to being fully oxidised in BCLC (where the desired product is heat and electricity from the heat). The reactions in the air reactor for BCLG and BCLC (eqn (5)) are the same, but in the fuel reactor, oxidation of the fuel (eqn (4)) occurs to a smaller extent^{6,16} with the predominant reaction being partial oxidation (eqn (12)) which produces syngas.

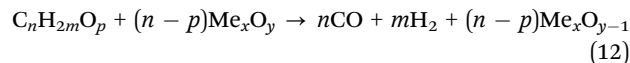

It should be noted that steam or CO₂ might be added into the fuel reactor to enhance steam reforming (eqn (13)) and CO₂ reforming (eqn (14)). In this case, BCLG can also be called chemical looping reforming (BCLR).

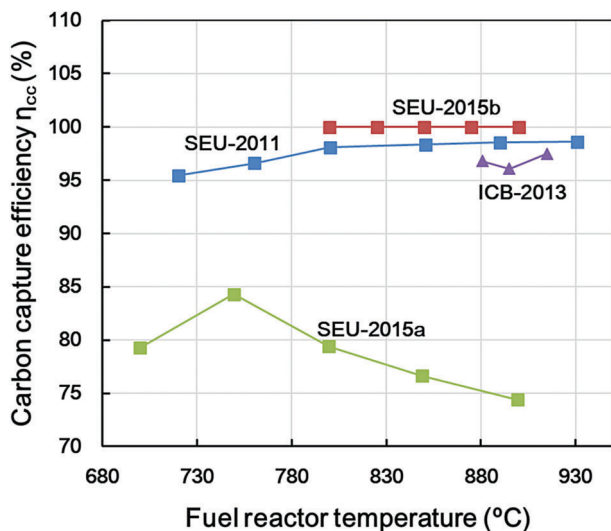
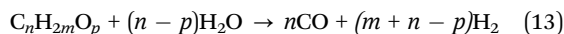

Fig. 7 Carbon capture efficiency comparison as a function of fuel reactor temperature for the different cases.



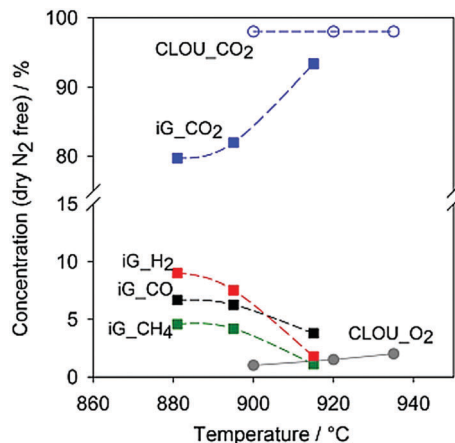

Fig. 8 Gas products from fuel reactors of iG-BCLC (iG in the figure) and OU-CLC (CLOU in the figure) at different temperatures. Reproduced from ref. 67 by permission from John Wiley & Sons Ltd.

Reactions (12) and (13) are strongly endothermic, and thus require an external heat supply to the fuel reactor. The major advantages of CLG include avoidance of direct air-fuel mixing, the availability of heat for CH₄-to-H₂ conversion without costly oxygen production, and higher H₂ production efficiency. The inorganic species present in biomass ash are effective gasification catalysts,⁴² which is a potential advantage for CLG with biomass, as opposed to coal.

The feasibility of various types of biomass-based BCLG using different OCs has been intensively investigated. Typically, woody biomass is used, and the commonly used OCs include Fe-based,^{71–73} Fe-ore,^{74–77} Ni-based,^{78–80} Ni modified Fe-ore,⁷⁶ Cu-based,⁸¹ Cu-ore,⁸² and Fe–Ni bimetallic OCs.⁸² Similar to the concept of OU-BCLC, appropriate OCs can release gaseous O₂ to partially oxidize the biomass feedstock and this process can be termed OU-BCLG. Partial oxidation can also be achieved by using OCs suitable for OU-BCLG, yet only one case was reported in the literature.⁸³ Representative cases of BCLG and OU-BCLG are compared and tabulated in Table 4.

In a pine sawdust-fuelled CLG (case HUST-2015), compared to Fe-based OC, Cu-based particles provided higher gas yield and carbon conversion efficiency but a lower cumulative concentration of gaseous C₂H_m and tar. The amount of tar produced decreased at higher temperatures on account of enhanced tar cracking.⁸¹ In another study (case GIE-2013), Fe₂O₃/Al₂O₃ was used as OCs with pine sawdust.⁷² Higher temperatures produced more CO and H₂, less residual char in the fuel reactor and reduced CO₂ concentration in the exhaust from the air reactor. The carbon conversion rate and gasification efficiency increased with an increase in temperature, and H₂ production was maximum at 870 °C.⁷² In a biochar-fuelled BCLG (case GIE-2014), a higher carbon conversion (55.56%) was obtained in comparison to the baseline experiment without OCs (5.52%).⁷⁶ Biomass char was catalytically pyrolysed because of the presence of deeply reduced products (metallic iron and nickel) which act as catalysts for char pyrolysis.⁷⁶

Temperature usually plays an important role in the BCLG processes. The influence of temperature on the gas properties

and efficiencies in a 10 kW_{th} interconnected fluidised bed reactor (case GIE-2015) is shown in Fig. 9. The total gas yield, and gas low heating value (LHV) increased with an increase in temperature from 670 °C to 900 °C. In addition, the carbon conversion and cold gas efficiency also increased with the increase in temperature.⁷¹ The reason for this is that high temperatures promote the cracking of tars from biomass gasification.⁵¹

Steam is usually supplied to the fuel reactor as a gasifying agent to accelerate biomass gasification. Steam also provides oxygen for biomass gasification. In case SEU-2016a, carbon the conversion efficiency increased initially and then remained nearly unchanged.⁷⁷ The optimal S/B ratio was determined as 1.0 for the highest syngas yield without sacrificing the maximal carbon conversion efficiency.

3.3. Biomass-based co-production looping process (BCCLP)

Some OCs, e.g. Fe-based materials, have several oxidation states and can be transformed sequentially into different forms in different reactors. In the BCCLP process, a gasifier is added between the typical air reactor and fuel reactor, and H₂ is produced from this gasifier rather than from the biomass conversion reactor (fuel reactor),^{11,88,89} as shown in Fig. 5c. It should be noted that co-production CLP is a pathway to produce H₂, which serves a different market to syngas. In the fuel reactor, Me_xO_y is reduced to Me_xO_{y–1} by CO and H₂ from biomass gasification, and CO and H₂ are then converted to CO₂ and H₂O. This reaction is the same as reaction (4) of BCLC.

In the steam reactor (gasifier), Me_xO_{y–1} is oxidised by H₂O to Me_xO_y, and pure H₂ is generated at the same time. The reaction is

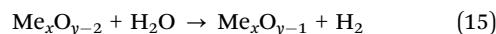

There are only a few studies of BCCLP and in these cases FeO/Fe₃O₄/Fe₂O₃ materials are the LMs. The cycle could be FeO–Fe₃O₄–FeO or FeO–Fe₃O₄–Fe₂O₃–FeO depending on whether extra Fe₃O₄ oxidation by air is introduced.⁹⁰

The reactions in the fuel reactor (including biomass gasification and Fe₂O₃/Fe₃O₄ reduction) are endothermic, and thus additional heat is needed. It should be noted that a small amount of Fe may also be generated during this period.⁹¹

In the steam reactor, FeO is oxidised to Fe₃O₄ by steam and H₂ is generated. This reaction is exothermic and low temperature is preferred. For Fe₂O₃/FeO-looping, Fe₃O₄ is then oxidised to Fe₂O₃ by air in the air reactor.

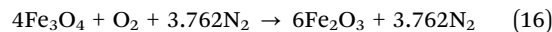

This exothermic reaction can heat OCs up to a very high temperature (1100 °C),¹¹ which is beneficial for the reaction in the fuel reactor. It should be noted that quite pure N₂ is the by-product of this process.

Systems utilising Fe₃O₄/FeO-looping presented higher gasification efficiency (60%) than that using Fe₂O₃/FeO-based looping (54%). The CO₂ sequestration rates of these two pathways were both higher than 90%.⁹⁰ Modelling of Fe₂O₃/FeO-looping BCCLP indicated that a high moisture content in biomass leads



Table 4 Summary of the key information of BCLG and OU-BCLG^a

Case no. (size)	Biomass	Oxygen carriers	Fuel reactor	Air reactor	Efficiency and remarks
HUST-2015 ^{81,84}	Pine sawdust	Copper ore (mainly CuO, CuFe ₂ O ₄) Hematite (mainly Fe ₂ O ₃ , Al ₂ O ₃ , SiO ₂) synthesised CuO/CuAl ₂ O ₄ or Fe ₂ O ₃ /Al ₂ O ₃	Fluidised bed reactor, with N ₂ atmosphere as fuel reactor conditions and air atmosphere as air reactor conditions. Operation temperature: 800 °C.		<ul style="list-style-type: none"> • Gas yield (N m³ kg⁻¹): CuO/CuAl₂O₄ (0.90) > Fe₂O₃/Al₂O₃ (0.82) > copper ore (0.79) > hematite (0.78). • Carbon conversion efficiency: CuO/CuAl₂O₄ (95.6%) > copper ore (83.2%) > Fe₂O₃/Al₂O₃ (81.7%) > hematite (64.6%). • Gasification efficiency: Fe₂O₃/Al₂O₃ (60.1%) > hematite (55.1%) > CuO/CuAl₂O₄ (30.8%) > copper ore (26.6%). • The Cu-based materials have higher reactivity for biomass pyrolysis and gasification, resulting in relatively higher carbon conversion and more tar-cracking.
GIE-2013 ^{72,74,75}	Pine sawdust	Natural hematite (91% as Fe ₂ O ₃)	Bubbling fluidised bed. Fluidising agent: Ar/steam. Operation temperature: 740–940 °C.	Bubbling fluidised bed	<ul style="list-style-type: none"> • The maximum gas yield of 1.06 N m³ kg⁻¹ and highest gasification efficiency of 83.31% were reached when a Fe₂O₃/C molar ratio of 0.23 was used. The oxygen carrier was gradually deactivated with an increase in reduction time owing to the loss of reactive lattice oxygen. Agglomeration and attrition of oxygen carriers over cycles were observed. • The overall reactivity of oxygen carriers increased with the loading of NiO. The presence of spinel-type NiFe₂O₄ greatly enhanced the char gasification. The carbon conversion reached up to 55.56% compared with char pyrolysis (5.52%).⁷⁶ • The oxidising atmosphere (CO₂, or H₂O) resulted in an increase in carbon conversion efficiency and suppressed oxygen conversion of the oxygen carrier. The order of reactivity is speculated as follows: pure oxygen > NiO > H₂O > iron ore > CO₂ > Al₂O₃.⁸⁵ • Operational time: 60 h. • Higher operating temperatures in fuel reactor resulted in higher syngas yield, cold gas efficiency, and carbon conversion. The synthesised oxygen carriers exhibited stable reactivity and resistance to agglomeration over 60 h operation.⁷¹ • The NiO-modified oxygen carriers showed higher gasification efficiency due to the synergistic effect between Fe₂O₃ and NiO. In addition, the modified oxygen carriers performed well over 11 cycles with good crystalline state.⁸² • Operational time: 52 h (20 cycles). • The overall char conversion rate increased with steam content in fuel reactor and reached a maximum at a steam content of 56.6%. The oxygen carriers maintained relatively stable reactivity after 20 cycles and a slight decrease in carbon conversion was reported. • The carbon conversion efficiency increased from 40.55% to 67.5% when the temperature of the fuel reactor increased from 650 °C to 850 °C. The syngas yield reached a maximum of 0.33 N m³ kg⁻¹ at 750 °C. CaO decoration can enhance the quality of syngas with low CO₂ emission. • The carbon conversion efficiency increased from 53.4% to 89.2% when the working temperature of the fuel reactor increased from 800 °C to 900 °C. The syngas yield reached the maximum of 0.74 N m³ kg⁻¹ at 860 °C. • In the batch reactor, carbon conversion efficiency increased within the tested temperature range. The hematite fraction posed a similar effect on the gasification performance between the batch reactor and the continuous reactor.
GIE-2014 ^{76,85}	Biomass char	Iron ore (90% as Fe ₂ O ₃) ⁷⁶ or NiO-modified iron ore ⁸⁵	TGA reactor, with argon/steam/CO ₂ atmosphere as fuel reactor conditions and air atmosphere as air reactor conditions. Operation temperature: 600–1200 °C.		<ul style="list-style-type: none"> • The overall reactivity of oxygen carriers increased with the loading of NiO. The presence of spinel-type NiFe₂O₄ greatly enhanced the char gasification. The carbon conversion reached up to 55.56% compared with char pyrolysis (5.52%).⁷⁶ • The oxidising atmosphere (CO₂, or H₂O) resulted in an increase in carbon conversion efficiency and suppressed oxygen conversion of the oxygen carrier. The order of reactivity is speculated as follows: pure oxygen > NiO > H₂O > iron ore > CO₂ > Al₂O₃.⁸⁵ • Operational time: 60 h. • Higher operating temperatures in fuel reactor resulted in higher syngas yield, cold gas efficiency, and carbon conversion. The synthesised oxygen carriers exhibited stable reactivity and resistance to agglomeration over 60 h operation.⁷¹ • The NiO-modified oxygen carriers showed higher gasification efficiency due to the synergistic effect between Fe₂O₃ and NiO. In addition, the modified oxygen carriers performed well over 11 cycles with good crystalline state.⁸² • Operational time: 52 h (20 cycles). • The overall char conversion rate increased with steam content in fuel reactor and reached a maximum at a steam content of 56.6%. The oxygen carriers maintained relatively stable reactivity after 20 cycles and a slight decrease in carbon conversion was reported. • The carbon conversion efficiency increased from 40.55% to 67.5% when the temperature of the fuel reactor increased from 650 °C to 850 °C. The syngas yield reached a maximum of 0.33 N m³ kg⁻¹ at 750 °C. CaO decoration can enhance the quality of syngas with low CO₂ emission. • The carbon conversion efficiency increased from 53.4% to 89.2% when the working temperature of the fuel reactor increased from 800 °C to 900 °C. The syngas yield reached the maximum of 0.74 N m³ kg⁻¹ at 860 °C. • In the batch reactor, carbon conversion efficiency increased within the tested temperature range. The hematite fraction posed a similar effect on the gasification performance between the batch reactor and the continuous reactor.
GIE-2015 (10 kW _{th}) ^{71,82}	Pine sawdust	Fe ₂ O ₃ /Al ₂ O ₃ (mass ratio = 7/3) ⁷¹ Fe ₂ O ₃ /Al ₂ O ₃ /NiO (mass ratio = 7/3/0.53) ⁸²	Bubbling fluidised bed. Fluidising agent: N ₂ . Operation temperature: 650–900 °C.	Fast fluidised bed.	<ul style="list-style-type: none"> • The overall reactivity of oxygen carriers increased with the loading of NiO. The presence of spinel-type NiFe₂O₄ greatly enhanced the char gasification. The carbon conversion reached up to 55.56% compared with char pyrolysis (5.52%).⁷⁶ • The oxidising atmosphere (CO₂, or H₂O) resulted in an increase in carbon conversion efficiency and suppressed oxygen conversion of the oxygen carrier. The order of reactivity is speculated as follows: pure oxygen > NiO > H₂O > iron ore > CO₂ > Al₂O₃.⁸⁵ • Operational time: 60 h. • Higher operating temperatures in fuel reactor resulted in higher syngas yield, cold gas efficiency, and carbon conversion. The synthesised oxygen carriers exhibited stable reactivity and resistance to agglomeration over 60 h operation.⁷¹ • The NiO-modified oxygen carriers showed higher gasification efficiency due to the synergistic effect between Fe₂O₃ and NiO. In addition, the modified oxygen carriers performed well over 11 cycles with good crystalline state.⁸² • Operational time: 52 h (20 cycles). • The overall char conversion rate increased with steam content in fuel reactor and reached a maximum at a steam content of 56.6%. The oxygen carriers maintained relatively stable reactivity after 20 cycles and a slight decrease in carbon conversion was reported. • The carbon conversion efficiency increased from 40.55% to 67.5% when the temperature of the fuel reactor increased from 650 °C to 850 °C. The syngas yield reached a maximum of 0.33 N m³ kg⁻¹ at 750 °C. CaO decoration can enhance the quality of syngas with low CO₂ emission. • The carbon conversion efficiency increased from 53.4% to 89.2% when the working temperature of the fuel reactor increased from 800 °C to 900 °C. The syngas yield reached the maximum of 0.74 N m³ kg⁻¹ at 860 °C. • In the batch reactor, carbon conversion efficiency increased within the tested temperature range. The hematite fraction posed a similar effect on the gasification performance between the batch reactor and the continuous reactor.
GIE-2016 ⁸⁶	Biomass char	Iron ore (90% as Fe ₂ O ₃)	Fixed bed reactor, with steam/N ₂ atmosphere as fuel reactor conditions and air atmosphere as air reactor conditions. Operation temperature: 850 °C.		<ul style="list-style-type: none"> • The overall reactivity of oxygen carriers increased with the loading of NiO. The presence of spinel-type NiFe₂O₄ greatly enhanced the char gasification. The carbon conversion reached up to 55.56% compared with char pyrolysis (5.52%).⁷⁶ • The oxidising atmosphere (CO₂, or H₂O) resulted in an increase in carbon conversion efficiency and suppressed oxygen conversion of the oxygen carrier. The order of reactivity is speculated as follows: pure oxygen > NiO > H₂O > iron ore > CO₂ > Al₂O₃.⁸⁵ • Operational time: 60 h. • Higher operating temperatures in fuel reactor resulted in higher syngas yield, cold gas efficiency, and carbon conversion. The synthesised oxygen carriers exhibited stable reactivity and resistance to agglomeration over 60 h operation.⁷¹ • The NiO-modified oxygen carriers showed higher gasification efficiency due to the synergistic effect between Fe₂O₃ and NiO. In addition, the modified oxygen carriers performed well over 11 cycles with good crystalline state.⁸² • Operational time: 52 h (20 cycles). • The overall char conversion rate increased with steam content in fuel reactor and reached a maximum at a steam content of 56.6%. The oxygen carriers maintained relatively stable reactivity after 20 cycles and a slight decrease in carbon conversion was reported. • The carbon conversion efficiency increased from 40.55% to 67.5% when the temperature of the fuel reactor increased from 650 °C to 850 °C. The syngas yield reached a maximum of 0.33 N m³ kg⁻¹ at 750 °C. CaO decoration can enhance the quality of syngas with low CO₂ emission. • The carbon conversion efficiency increased from 53.4% to 89.2% when the working temperature of the fuel reactor increased from 800 °C to 900 °C. The syngas yield reached the maximum of 0.74 N m³ kg⁻¹ at 860 °C. • In the batch reactor, carbon conversion efficiency increased within the tested temperature range. The hematite fraction posed a similar effect on the gasification performance between the batch reactor and the continuous reactor.
SEU-2015 (25 kW _{th}) ⁸⁰	Rice straw	NiO/Al ₂ O ₃ (mass ratio = 3/2) or with CaO addition (10%)	Bubbling fluidised bed. Fluidising agent: steam/N ₂ . Operation temperature: 650–850 °C.	High-velocity fluidised bed.	<ul style="list-style-type: none"> • The overall reactivity of oxygen carriers increased with the loading of NiO. The presence of spinel-type NiFe₂O₄ greatly enhanced the char gasification. The carbon conversion reached up to 55.56% compared with char pyrolysis (5.52%).⁷⁶ • The oxidising atmosphere (CO₂, or H₂O) resulted in an increase in carbon conversion efficiency and suppressed oxygen conversion of the oxygen carrier. The order of reactivity is speculated as follows: pure oxygen > NiO > H₂O > iron ore > CO₂ > Al₂O₃.⁸⁵ • Operational time: 60 h. • Higher operating temperatures in fuel reactor resulted in higher syngas yield, cold gas efficiency, and carbon conversion. The synthesised oxygen carriers exhibited stable reactivity and resistance to agglomeration over 60 h operation.⁷¹ • The NiO-modified oxygen carriers showed higher gasification efficiency due to the synergistic effect between Fe₂O₃ and NiO. In addition, the modified oxygen carriers performed well over 11 cycles with good crystalline state.⁸² • Operational time: 52 h (20 cycles). • The overall char conversion rate increased with steam content in fuel reactor and reached a maximum at a steam content of 56.6%. The oxygen carriers maintained relatively stable reactivity after 20 cycles and a slight decrease in carbon conversion was reported. • The carbon conversion efficiency increased from 40.55% to 67.5% when the temperature of the fuel reactor increased from 650 °C to 850 °C. The syngas yield reached a maximum of 0.33 N m³ kg⁻¹ at 750 °C. CaO decoration can enhance the quality of syngas with low CO₂ emission. • The carbon conversion efficiency increased from 53.4% to 89.2% when the working temperature of the fuel reactor increased from 800 °C to 900 °C. The syngas yield reached the maximum of 0.74 N m³ kg⁻¹ at 860 °C. • In the batch reactor, carbon conversion efficiency increased within the tested temperature range. The hematite fraction posed a similar effect on the gasification performance between the batch reactor and the continuous reactor.
SEU-2016a (25 kW _{th}) ⁷⁷	Rice husk	Natural hematite (83% as Fe ₂ O ₃)	Bubbling fluidised bed. Fluidising agent: steam/N ₂ . Operation temperature: 800–900 °C.	High-velocity fluidised bed.	<ul style="list-style-type: none"> • The overall reactivity of oxygen carriers increased with the loading of NiO. The presence of spinel-type NiFe₂O₄ greatly enhanced the char gasification. The carbon conversion reached up to 55.56% compared with char pyrolysis (5.52%).⁷⁶ • The oxidising atmosphere (CO₂, or H₂O) resulted in an increase in carbon conversion efficiency and suppressed oxygen conversion of the oxygen carrier. The order of reactivity is speculated as follows: pure oxygen > NiO > H₂O > iron ore > CO₂ > Al₂O₃.⁸⁵ • Operational time: 60 h. • Higher operating temperatures in fuel reactor resulted in higher syngas yield, cold gas efficiency, and carbon conversion. The synthesised oxygen carriers exhibited stable reactivity and resistance to agglomeration over 60 h operation.⁷¹ • The NiO-modified oxygen carriers showed higher gasification efficiency due to the synergistic effect between Fe₂O₃ and NiO. In addition, the modified oxygen carriers performed well over 11 cycles with good crystalline state.⁸² • Operational time: 52 h (20 cycles). • The overall char conversion rate increased with steam content in fuel reactor and reached a maximum at a steam content of 56.6%. The oxygen carriers maintained relatively stable reactivity after 20 cycles and a slight decrease in carbon conversion was reported. • The carbon conversion efficiency increased from 40.55% to 67.5% when the temperature of the fuel reactor increased from 650 °C to 850 °C. The syngas yield reached a maximum of 0.33 N m³ kg⁻¹ at 750 °C. CaO decoration can enhance the quality of syngas with low CO₂ emission. • The carbon conversion efficiency increased from 53.4% to 89.2% when the working temperature of the fuel reactor increased from 800 °C to 900 °C. The syngas yield reached the maximum of 0.74 N m³ kg⁻¹ at 860 °C. • In the batch reactor, carbon conversion efficiency increased within the tested temperature range. The hematite fraction posed a similar effect on the gasification performance between the batch reactor and the continuous reactor.
SEU-2016b ⁸⁷	Rice husk	Natural hematite (83% as Fe ₂ O ₃)	Batch fluidised bed reactor, with steam/N ₂ atmosphere as fuel reactor conditions and air atmosphere as air reactor conditions. Operation temperature: 750–900 °C.		<ul style="list-style-type: none"> • The overall reactivity of oxygen carriers increased with the loading of NiO. The presence of spinel-type NiFe₂O₄ greatly enhanced the char gasification. The carbon conversion reached up to 55.56% compared with char pyrolysis (5.52%).⁷⁶ • The oxidising atmosphere (CO₂, or H₂O) resulted in an increase in carbon conversion efficiency and suppressed oxygen conversion of the oxygen carrier. The order of reactivity is speculated as follows: pure oxygen > NiO > H₂O > iron ore > CO₂ > Al₂O₃.⁸⁵ • Operational time: 60 h. • Higher operating temperatures in fuel reactor resulted in higher syngas yield, cold gas efficiency, and carbon conversion. The synthesised oxygen carriers exhibited stable reactivity and resistance to agglomeration over 60 h operation.⁷¹ • The NiO-modified oxygen carriers showed higher gasification efficiency due to the synergistic effect between Fe₂O₃ and NiO. In addition, the modified oxygen carriers performed well over 11 cycles with good crystalline state.⁸² • Operational time: 52 h (20 cycles). • The overall char conversion rate increased with steam content in fuel reactor and reached a maximum at a steam content of 56.6%. The oxygen carriers maintained relatively stable reactivity after 20 cycles and a slight decrease in carbon conversion was reported. • The carbon conversion efficiency increased from 40.55% to 67.5% when the temperature of the fuel reactor increased from 650 °C to 850 °C. The syngas yield reached a maximum of 0.33 N m³ kg⁻¹ at 750 °C. CaO decoration can enhance the quality of syngas with low CO₂ emission. • The carbon conversion efficiency increased from 53.4% to 89.2% when the working temperature of the fuel reactor increased from 800 °C to 900 °C. The syngas yield reached the maximum of 0.74 N m³ kg⁻¹ at 860 °C. • In the batch reactor, carbon conversion efficiency increased within the tested temperature range. The hematite fraction posed a similar effect on the gasification performance between the batch reactor and the continuous reactor.



Table 4 (continued)

Case no. (size)	Biomass	Oxygen carriers	Fuel reactor	Air reactor	Efficiency and remarks
CQU-2016 ⁸³	Walnut shell	CuO supported on MgAl ₂ O ₄	Tubular fixed bed reactor with switchable gas atmosphere: with N ₂ atmosphere as fuel reactor conditions and air atmosphere as air reactor conditions. Operation temperature: 600–1000 °C.		• Compared to pure CuO, the addition of MgAl ₂ O ₄ can effectively improve the stability and reactivity resulting in a higher yield of syngas.

^a Case no: CQU: Chongqing University, China; HUST: Huazhong University of Science and Technology, China; GIE: Guangzhou Institute of Energy Conversion, China and SEU: Southeast University, China.

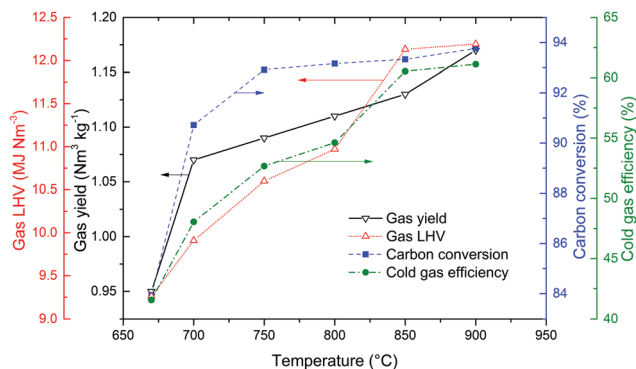

Fig. 9 Influence of temperature on the working properties of BCLG.⁷¹

to a low OC conversion rate, low H₂ production, and low energy efficiency. Therefore, biomass with less than 5 wt% moisture is required. From the model, the fuel reactor was required to be operated at approximately 900 °C and the steam reactor at higher than 600 °C, with the combustor 100–450 °C higher than the steam reactor. Overall, the Fe₂O₃/FeO looping BCCLP had 10–25% higher efficiency than conventional biomass combustion and gasification processes.¹¹

3.4. Biomass-based calcium looping combustion (BCaLC)

During conventional biomass combustion in air, the produced CO₂ is mixed with N₂. The excess air coefficient is usually higher than 1 for the complete combustion, so there will be some excess O₂ in the fuel gas, as shown in eqn (17).



CO₂ could be captured *in situ*, where CaO is frequently used for the capture through the carbonation reaction.^{92–95}



It should be noted that, this reaction is exothermic and is favoured at low temperatures. Therefore, the combustion must take place at a relatively low temperature (~700 °C).^{92,93}

In the calciner/regenerator, CaCO₃ is converted to CaO at a temperature higher than 800 °C.

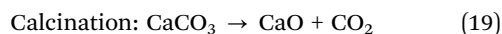

CaO is then transferred back to the fuel reactor to close the cycle, as shown in Fig. 5d.^{92–95}

In a 30 kW interconnected fluidised bed reactor, biomass combustion with *in situ* carbon capture by CaO was tested. The CO₂ capture efficiencies were higher than 80%. CO and CH₄ were detected, perhaps due to pulsed feeding or an inappropriate air/fuel mixture.⁹³

Further, the concept of BCaLC was experimentally tested in a 300 kW_{th} pilot reactor at 700 °C. According to the authors, a combustion efficiency close to 100% and carbon capture efficiency between 70 and 95% could be achieved using wood pellet as the fuel.⁹⁴

A large-scale dedicated biomass power plant with CaO for *in situ* CO₂ capture was also modelled by the same group. With a heat exchanger network, this system could have a higher net power generation efficiency compared to oxy-fuel biomass combustion. With a CO₂ purification and compression process, a CO₂ stream with purity >95 mol% could be obtained.⁹⁵

3.5. Biomass-based calcium looping gasification (BCaLG)

In a typical BCaLG, as shown in Fig. 5e, the CO₂ produced during the steam gasification can be captured *in situ* by CaO inside the gasifier. Although group I (alkali metals) hydroxides are more effective to produce high purity H₂ with *in situ* carbon capture than group II (alkaline earth metals) hydroxides,⁹⁶ more research utilises CaO as a sorbent because of its lower cost and relatively easier recovery. The advantages of BCaLG are numerous compared to other pathways. The CO concentration in the produced gas is quite low, and thus the gas meets the requirements for fuel cell applications. Additionally, any H₂S and HCl from biomass gasification can also be removed *in situ* by CaO.⁹⁷

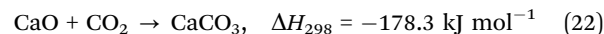
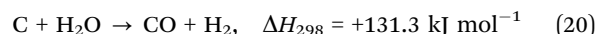

Reaction (20) is strongly endothermic, and generally is significant at high temperatures (>1000 °C), whereas reaction (21) is exothermic and usually requires a catalyst at a low temperature (<400 °C), and reaction (22) generally operates between 600–750 °C at atmospheric pressure. Traditional H₂ manufacturing splits reactions (20) and (21) into separate reactors, since the temperature difference between the different reactions lowers the system efficiency. In BCaLG, reaction (22) can provide heat for reaction (20). Meanwhile, the *in situ* capture of CO₂ promotes reactions (20) and (21), which in turn



increases the production of H₂. At the same time, CaO catalyses the gasification process and tar reforming, which improves the reaction rate and gaseous product formation according to reaction (23):⁹⁸

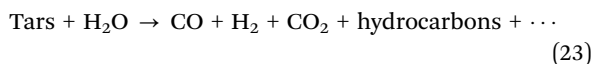

This concept allows a single-loop process with *in situ* CO₂ capture for atmospheric biomass steam gasification to yield relatively pure H₂ gas which can use calcined limestone (or potentially other options such as demolition waste⁹⁹) as a CO₂ sorbent.¹⁰⁰ The system energy efficiency can reach 88% with almost complete CO₂ capture and an H₂ content in the produced reformed gas of up to 71% with negligible CO₂.¹⁰⁰

Gu *et al.* performed a thermodynamic analysis of biomass-to-synthetic natural gas (SNG) with BCaLG as the first step of the system.¹⁰¹ At Ca/biomass = 0.83, *i.e.* a stoichiometric ratio of 1, the CH₄ content in SNG was maximised. At S/B = 0.6, the overall energy and exergetic efficiencies reached the maximum. The optimal performances showed that the process is competitive compared to the traditional SNG production process. However, the major limitation in BCaLG using CaO is the deactivation of sorbents due to sorbent sintering and biomass ash.¹⁰² An overall summary of representative cases of BCaLG is tabulated in Table 5.

3.6. Sorption enhanced BCLG (SE-BCLG)

Both OC and CC can be used in one system, as shown in Fig. 5f. Oxidation, steam reforming, water-gas shift reaction and *in situ* CO₂ removal are combined to produce H₂ auto-thermally using mixed Ni/CaO.¹⁰³

There have also been some attempts to conduct SE-BCLG using liquid biomass as a feedstock, where both OCs and CCs were used for the looping. In a study on steam reforming of cooking oil, NiO was used as the OC and catalyst, and dolomite was used as a CO₂ sorbent. At a relatively low temperature (600 °C), high-purity H₂ (> 95%) was obtained.^{104,105} From another study on process simulation, a maximum of 153.4 g H₂ kg⁻¹ corn stover was obtained.¹⁰⁶

At least three reactors are needed for this system: one for reforming, another for CC regeneration, and the third for OC reduction. Another experimental study reported that NiO cannot be fully reduced to Ni, which indicates that the conditions in the reactors are unable to satisfy the requirements for the ideally full conversion of both NiO–Ni and CaO–CaCO₃.¹⁰³

4. Design of looping materials (LMs)

4.1. Oxygen carrier (OC) providing lattice oxygen: LMs for BCLC, BCLG and BCCLP

From a practical standpoint, ideal OCs in BCLPs should undergo multiple cycles with minimal loss in physical integrity and chemical reactivity. The reduction/oxidation potential of a metal oxide can be predicted using a modified Ellingham diagram, which depicts the standard Gibbs free energies of reactions as a function of temperature. A typical diagram for

the comparison of commonly used OCs is shown in Fig. 10a, and the same diagram has been adapted for the selection of OCs in various CLPs.^{15,16} Three key reactions associated with CO₂, H₂, CH₄ and CO are highlighted as reaction lines 1, 2 and 3.

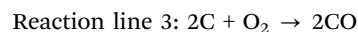
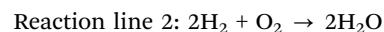
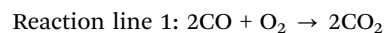

Based on the three key reactions, OCs can fall into three zones/categories according to their potential to fully or partially oxidise the fuel, as shown in Fig. 10b.

Zone A: materials in this zone fall in the area above lines 1 and 2. These materials exhibit strong oxidising potentials and can be used for full/partial oxidation of fuel. Both CO and H₂ are readily oxidised. Metal oxides in this zone include NiO, CuO, CoO, Fe₂O₃ and Fe₃O₄.

Zone B: materials in this zone fall into the area below lines 1 and 2, but above line 3. These materials can only produce CO or H₂, and the yielded syngas cannot be further oxidised. Thus, the materials in this zone are theoretically ideal for partial oxidation of fuel or for CLG.

Zone C: materials in this zone stay in the area below line 3 and are inert for this application.

Materials between lines 1 and 2 are potential choices as partial oxidation materials, which can oxidise H₂ into H₂O, leaving CO unreacted. For example, SnO₂ falls into this area.

For CLC applications, full oxidation is necessary in the fuel reactor, thus potential OCs can be selected from Zone A. The CO₂ purity in the exit gas from the fuel reactor reflects the energy conversion efficiencies and commercial viability of the overall CLC systems. According to the reaction thermodynamics, Fe- and Cu-based materials can fully convert fuel into CO₂ and H₂O, but Ni- or CaS-based materials result in CO leakage.

Partial oxidation can be achieved through two approaches. First, using metal oxides in Zone B to predominantly produce H₂ and CO, which cannot be further oxidised due to thermodynamic restrictions. Fig. 10a demonstrates that CeO₂ and FeO are representative metal oxides in this zone. The other approach is to utilise sub-stoichiometric quantities of the metal oxides in Zone A. For instance, a CLG process using NiO/Ni, can be operated so that the air reactor is starved, thus producing a mixture of NiO : Ni (7 : 3) instead of fully regenerating all of the Ni to NiO.¹¹⁰ Therefore, less oxygen is transferred to the fuel reactor. Additionally, excess steam can be introduced into the fuel reactor to suppress carbon deposition since Ni is also a strong catalyst for CH₄ decomposition.

Ellingham diagrams can only provide theoretical indications for OCs selection. A combination of reaction kinetics, reactants mixing ratio, contact time and process design determines the actual performance of the system with a given OC.

The typically used OCs are Ni, Fe, Cu, Mn and Co-based materials, among which Fe and Ni-based are the most popular with around 1500 h and 1800 h of operation experience



Table 5 Summary of the key information of BCaLG^a

Case no. (size)	Biomass	CO ₂ carriers	Gasifier	Regenerator	Efficiency and remarks
AIT-2014 ¹⁰⁷	Pine sawdust	Calcined limestone (95.5% as CaO)	Bubbling fluidised bed, fluidised by steam. Operation temperature: 500–650 °C.	Circulating fluidised bed, fluidised by air. Operation temperature: 900 °C.	<ul style="list-style-type: none"> • The maximum H₂ and H₂ yield reached up to 78% and 451 mL g⁻¹ of biomass. Compared to the CaO-based bubbling fluidised bed gasification, BCaLG resulted in 15% higher concentration of H₂, less tar, and almost double the yield of H₂. • The H₂ purity can reach up to 71% for a Ca/C ratio of 1 and S/B ratio of 1.5. About 40% of the CaO can be regenerated at 800 °C for 1 h.
DU-2009 ¹⁰⁰	Sawdust	CaO	Bubbling fluidised bed, fluidised by steam. Operation temperature: 500–600 °C.	Circulating fluidised bed, fluidised by CO ₂ . Operation temperature: 800 °C.	<ul style="list-style-type: none"> • The H₂ content reached up to 60–70% at a steam/biomass weight ratio (S/B ratio) of 0.38–0.59 and CaO/biomass weight ratio of 20 at the reactor temperature of 700–800 °C. The limestone was deactivated irreversibly after 8 cycles due to the formation of inorganic adhesions. • Operational time: ~50 h. • The CDW behaves similarly to the HPC and CL. The increase in S/C ratio led to an increase in purity of H₂. For CDW, the CO₂ capture efficiency reached up to 56.4% with high-grade H₂ produced. In addition, CDW sorbents were found to be less susceptible to deactivation over the regeneration cycles. • Significant CO₂ removal and an increased conversion H₂ was reported. The H₂ content reached up to 75% with a low tar content (≤1 g N m⁻³).
DUT-2008 ¹⁰²	Pine sawdust	Mixture of calcined olivine (mainly MgO and SiO) and limestone (mainly CaO)	Fixed bed reactor with steam atmosphere as gasifier conditions and air atmosphere as regenerator conditions. Operation temperature: 650–800 °C.		
UN-2012 ⁹⁹	Pine sawdust	Concrete and demolition waste (CDW)/calcined limestone (CL)/hydrated Portland cement (HPC)	Pressurized TGA with steam/N ₂ atmosphere as gasifier conditions and N ₂ atmosphere as regenerator conditions. Operation temperature: 650–900 °C.		
VUT-2009 (100 kW to 8 MW fuel input) ^{108,109}	Wood	Limestone	Steam fluidised gasifier containing olivine as bed material. Bed temperature: 850–900 °C.	Air fluidised regenerator.	

^a Case no: AIT: Asian Institute of Technology, Thailand; DU: Dalhousie University, Canada; DUT: Dalian University of Technology, China; UN: the University of Newcastle, Australia and VUT: Vienna University of Technology, Austria.

reported, respectively.¹¹¹ Based on the key information (oxygen transport capacity, melting point, cost, reactivity and resistance to agglomeration or attrition), the OCs are compared in Fig. 11.

The oxygen transport capability R_O is used to evaluate the maximum oxygen transport between the fully oxidised, m_o , and reduced, m_r , forms of OC:

$$R_O = \frac{m_o - m_r}{m_o} \quad (24)$$

Ni-Based materials. Metallic Ni can serve as a strong reforming catalyst to achieve nearly complete methane conversion. Its high catalytic reactivity is also applicable to other light hydrocarbons.¹¹² However, increased circulation can cause a decrease in metallic Ni in the materials which results in a significantly weakened catalytic performance.¹¹³ In addition, pure NiO suffers from low porosity which leads to a suppressed reaction rate.¹¹⁴ Toxicity and high cost also impede the application of Ni. In addition, Ni-based materials can be readily poisoned by sulphur, where the negative effects of sulphur were observed in operations;¹¹⁵ however, this is generally less problematic for biomass than coal.

Fe-Based materials. Despite their low oxygen transport capacity and relatively low reactivity, iron-based materials are still regarded as a good option for OCs owing to their low cost, high mechanical strength, high melting points and environmentally benign nature. Previous studies demonstrated that Fe-based materials exhibit acceptable reactivity for H₂ and CO, with weak reactivity for CH₄.^{116,117} In addition, the advantages of Fe-based materials include almost no tendency for carbon formation¹¹⁸

or sulphide/sulphate formation.¹¹⁹ The drawback of Fe-based materials is the agglomeration issue reported to be associated with the formation of magnetite.¹²⁰ Due to its low oxygen transport capacity and limited solid circulation rate, the weight content of Fe₂O₃ cannot be lower than 10%.¹¹⁷

Cu-Based materials. The oxidised form of copper is CuO, which can be reduced to Cu₂O or Cu. Cu-based materials show both high reactivity and oxygen transfer capacity, and their relatively low cost and low toxicity make them an attractive choice as OCs. Additionally, sulphurous impurities in the fuel do not significantly affect the performance of Cu-based OCs.¹²¹ Furthermore, SiO₂, TiO₂ or Al₂O₃ supported Cu-based materials exhibit excellent chemical and mechanical stability.¹²² The main drawback of Cu-based materials as OCs is agglomeration due to the low melting point of Cu (1085 °C). It is recommended that the fuel reactor be operated at a temperature < 800 °C to avoid the melting problem. This is less of an issue for BCLPs owing to the more reactive chars produced from biomass than coal, so that lower temperatures can be used in the system.

Mn-Based materials. Similar to Fe-based materials, Mn-based materials exhibit low toxicity and are inexpensive. The theoretical oxygen transport capacity of Mn is higher than Fe. However, Mn has generally received less attention, with only a few published reports. The interactions between Mn and some typical supporting materials (Al₂O₃, MgAl₂O₄, SiO₂ or TiO₂) can form stable and unreactive materials resulting in inhibited reactivity.^{116,123} However, Mn-based materials supported on bentonite or ZrO₂ performed well through consecutive redox cycles.^{124,125} Similar



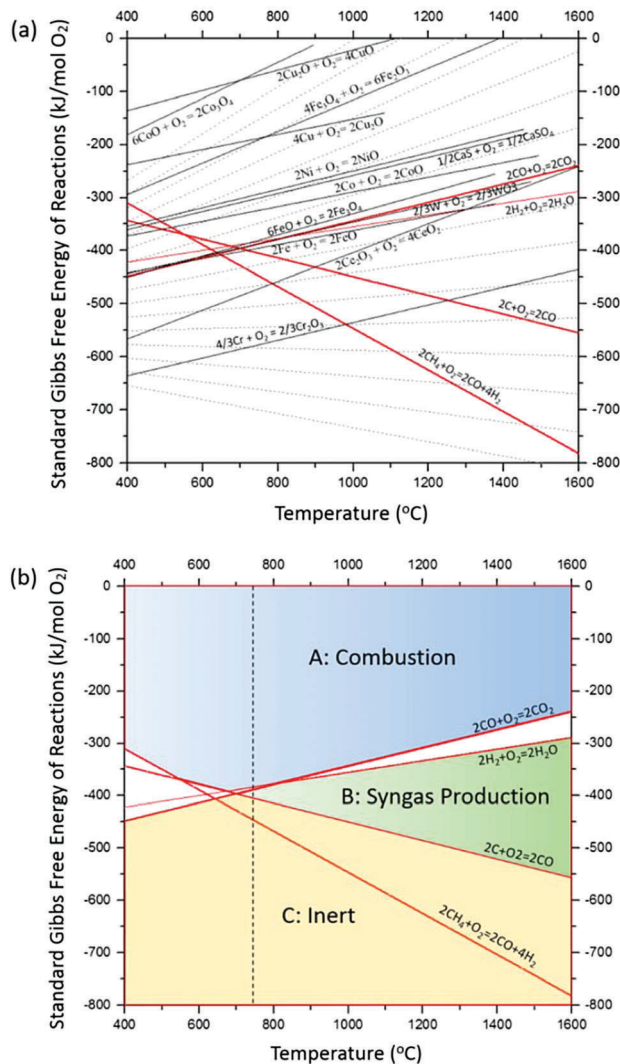

Fig. 10 (a) Modified Ellingham diagram for oxygen carrier comparison and (b) zone of metal oxides for chemical looping. Reproduced from ref. 15 by permission from John Wiley & Sons Ltd.

to Ni, the drawback of Mn-based materials is that their reactivity can also be suppressed by the presence of H₂S;¹²⁴ however, this is generally less of a problem for biomass than coal.

Co-Based materials. Cobalt has several oxidation states and Co₃O₄ is not thermodynamically stable at temperatures > 900 °C. For CLP application, the loop between CoO and Co is the most commonly used.⁶ Cobalt oxide can serve as an OC due to its high reactivity and oxygen transport capacity; however, it also suffers from high cost and environmental concerns. Overall, Co-based materials have attracted little attention. Cobalt oxides can react with common inert supports such as Al₂O₃, MgO, and TiO₂ forming unreactive phases (CoAl₂O₄, Mg_{0.4}Co_{0.6}O, and CoTiO₃, respectively) which result in almost complete loss of reactivity.^{126,127} The drawbacks of Co-based materials include their high cost and negative health effects, which deter their commercial use in large-scale operations.

The total cost includes the cost of reactive materials and inert supports (including replacement) and also the manufacturing

cost. The general cost of the commonly used metal based materials follows the order of Co > Ni > Cu > Fe > Mn-based materials,^{6,128} as shown in Fig. 11.

Environmental and health concerns about these materials are also important for the operation and safety of the whole process. In general, Ni- and Co-based materials engender the highest safety concerns during operation. Ni-based materials are potentially carcinogenic in nature. Thus far, the limited focus on the environmental aspects of LMs during their lifecycle has indicated that these are not “immediate showstoppers for the process”.⁶

In summary, typical OCs based on Ni, Fe, Cu, Mn and Co and their oxides have been developed and intensively investigated and compared. Similar to CLPs fuelled by other feedstocks, Fe- and Ni-based OCs are still the most popular for BCLPs. As shown in Fig. 11c, the low sulphur content of biomass is less of an issue for Ni and Mn-based OCs, which are easily poisoned by H₂S or COS. The chars of biomass are more reactive than coal-chars, and the high fraction of volatile matter of biomass makes biomass a more reactive solid feedstock. Although biomass has a low ash content, the low melting point of its ash can cause potential issues with the agglomeration of OCs. More details about the effect of biomass ash can be found in Section 5.1.

4.2. Oxygen carrier (OC) providing molecular oxygen: LMs for CLOU (OU-BCLC and OU-BCLG)

Thermodynamically, a limited number of metal oxides can match the requirements of CLOU processes, especially in consecutive redox cycles. Only the OCs having a suitable equilibrium partial pressure of oxygen gas at the desired temperature range (800–1200 °C) can serve as OCs for CLOU. Thus, far three metal oxide pairs have been proposed: CuO/Cu₂O, Mn₂O₃/Mn₃O₄, and Co₃O₄/CoO, and the proposed reversible reactions are:⁵⁷

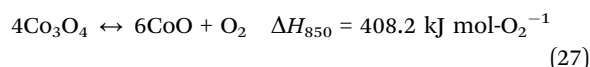
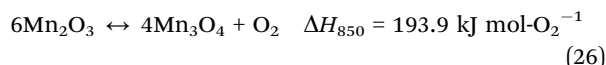
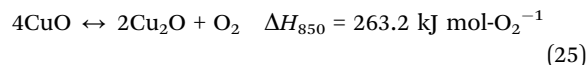

The reactions between carbon/coal and Cu- or Mn-based OCs in the fuel reactor are exothermic. However, the reaction for Co-based OCs is endothermic. Therefore, a higher operation temperature is required for Co-based OCs than that for Cu- or Mn-based OCs. The endothermic nature of the reaction combined with the high cost of Co₃O₄ makes this type of OC unattractive. Thus, only Cu- and Mn-based materials are promising choices for CLOU.

The low melting point and agglomeration issues can be ignored for Cu-based OCs since no metallic Cu is involved in the loop of CLOU. Screening tests on 25 types of Cu-based materials were conducted in successive cycles in a thermogravimetric analyser (TGA), and it was found that CuO supported on MgAl₂O₄ and ZrO₂ are the most promising owing to their stable reactivity.¹²⁹



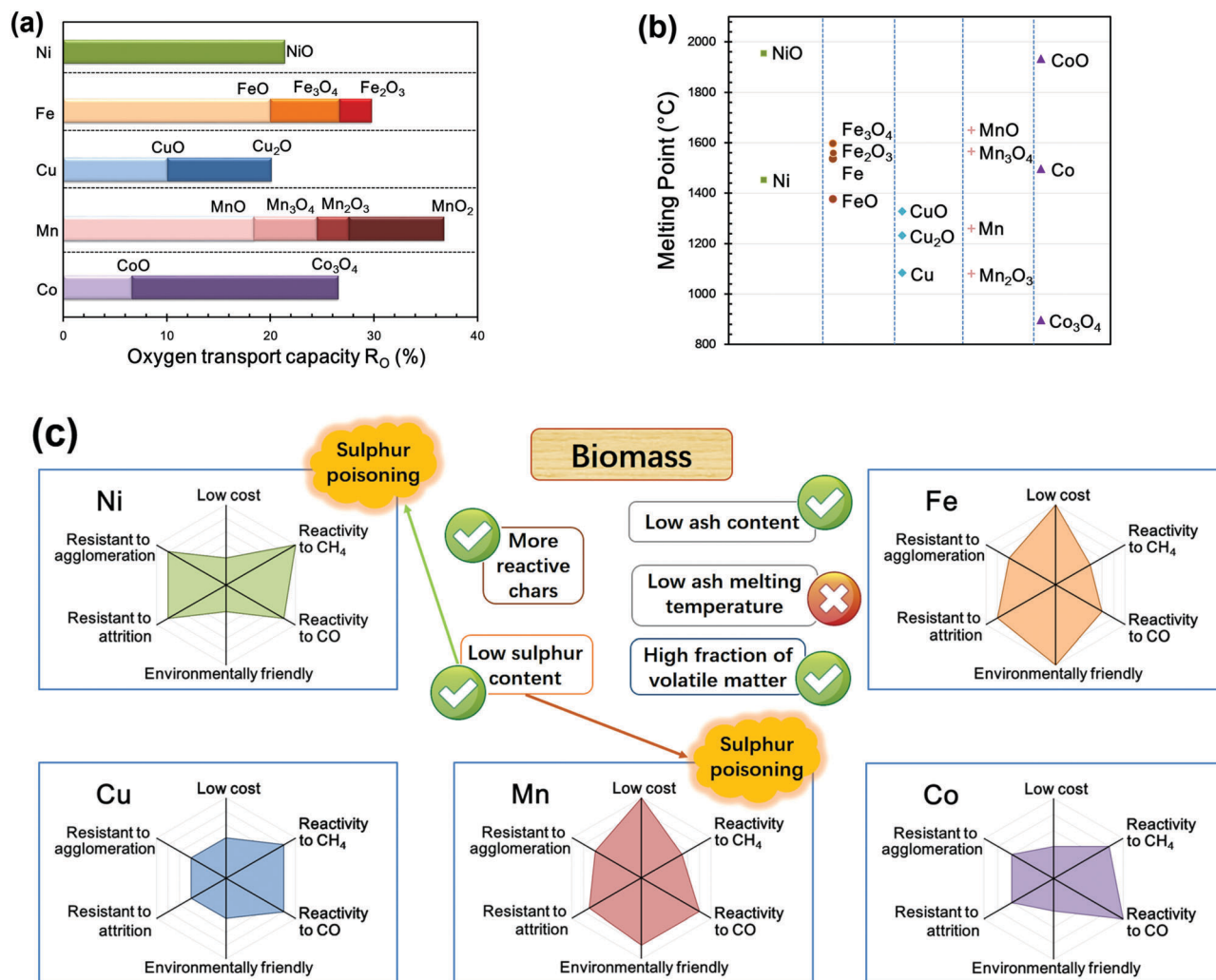

Fig. 11 Comparison of Ni, Fe, Cu, Mn and Co-based oxygen carriers: (a) oxygen transport capacity, (b) melting point and (c) summary for cost, reactivity and resistance to agglomeration or attrition.

For Mn-based materials, natural manganese ore or the addition of Fe₂O₃, SiO₂ and NiO were tested and mixing with Fe₂O₃ was observed to be the most effective way to increase their overall reactivity.^{130,131} A spinel perovskite structured material, CaMn_{0.875}Ti_{0.125}O₃, was also developed as an OC for CLOU, although its performance was not as good as that of Cu-based materials.¹³² As discussed in Section 3, limited studies are focused on OU-BCLC and OU-BCLG, therefore more operational experience is necessary.

4.3. CO₂ carrier (CC): LMs for BCaLC and BCaLG

Typical steam gasification of biomass suffers from two undesirable issues: CO₂ from the water-gas shift reaction and the formation of tar. Thus, the requirements for CO₂ carrier and biomass conversion catalysts include high CO₂ capture capacity and selectivity as well as tar cracking ability. The use of CaO is also attractive since it may serve as both a CO₂ sorbent and alkaline catalyst during biomass gasification.¹³³ Since CaO can be regenerated in a calciner through calcium looping, BCaLG has been proposed.⁹⁸

Many CaO-based CO₂ sorbents exhibit poor mechanical properties which cause them to degrade by attrition or elutriation. Furthermore, their sorption capacity decays rapidly over multiple cycles due to sintering.^{134,135} To enhance the recyclability of CaO, steam can be introduced into the regenerator.¹³⁶ In addition to its use as an LM and catalyst, since limestone is extremely cheap and quite robust, CaO can also serve as a bed material or heat carrier to transfer heat from the regenerator (850–900 °C) to the gasifier (600–700 °C), where the exothermic carbonation reaction in the gasifier can also supply some heat.

Due to the high moisture content of biomass, the interaction of CaO with H₂O is critical. It has been reported that H₂O could significantly enhance the kinetics of the CaO carbonation process. Compared to the dry carbonation of CaO, wet carbonation is nine times faster.¹³⁷ Thus, the presence of moisture in biomass may pose certain positive effects in BCaLC and BCaLG.

Another important feature of biomass is its low ash melting point. Due to the thermodynamics of CaO, carbonation is favoured at low temperatures, so the biomass reactor temperature is usually lower than 700 °C, which is beneficial to prevent biomass



ash from melting.¹⁰¹ It has also been reported that the high sulphur content of coal may result in the sulphation of CaO which leads to deactivation. Calcium sulphate is inert compared to calcium carbonate and is difficult to remove during sorbent regeneration.¹³⁸ This situation is less severe for biomass owing to its low sulphur content. It has even been reported that a CO₂ sorbent prepared from rice husk ash and CaO hydration presented higher carbonation conversions than hydrated CaO or dry CaO during multiple tests. The reason for this was that the rice husk ash/CaO exhibited better anti-sintering behaviour compared to other sorbents.¹³⁹

5. Challenges and opportunities

Although BCLPs have many potential benefits over the conventional biomass thermochemical methods and coal-fuelled CLPs, to date, this technology has not been widely commercialised. There are a number of issues associated with this technology that have to be considered and solved for its scale-up and commercialisation.

5.1. Deactivation of looping materials during biomass conversion

The stability of LMs is a crucial issue. Chemical looping requires the characteristics of LMs to be stable (low attrition and thermal stability) after many cycles. There are many reasons that may cause the deactivation of LMs during BCLPs.

Agglomeration. The agglomeration of LMs is a serious issue and can cause bed defluidisation and LM deactivation. Ni-based materials have not been found to exhibit agglomeration except when TiO₂ was used as the support.¹⁴⁰ Agglomeration of Fe-based materials can occur when magnetite (Fe₃O₄) transforms into wustite (FeO) during the operation.¹⁴¹ Iron-oxide doped with a composite support maintained stable reactivity and strength for several hundred cycles.^{16,17} The low melting point of Cu (1085 °C) causes a high tendency to agglomerate,¹⁴¹ but may potentially be ameliorated by dopants and optimising the synthetic methods.

Attrition. In a fluidised bed, the attrition of materials is quite crucial for their lifetimes. Researchers have tried to evaluate the attrition behaviour of materials based on standard crushing tests under identical operation conditions, although these tests only give an approximate indication of their lifetimes. Besides physical attrition, chemical stress during redox cycles should also be taken into account.⁶

Carbon deposition. Carbon deposition on LMs can reduce their reactivity and performance and has been widely investigated, where its extent depends on the metal oxide, inert support, H₂O/fuel ratios^{6,142–145} and oxygen availability. Carbon deposition occurs when the fuel gas combustion cannot take place.⁶ Interestingly, for Ni- or Cu-based materials, carbon deposition was observed even when the OC conversion was higher than 75%.¹⁴⁶

Sulphur. The sulphur from the fuels may be present as H₂S and COS in a reductive atmosphere. During CLPs, the reaction between sulphur compounds and looping materials may be inevitable. For example, Ni₃S₂ was formed when Ni/NiO was used as an OC. The low boiling point of Ni₃S₂ (789 °C) may

cause some difficulties in the process.¹⁴⁰ The sulphuration of CaO can also cause deactivation. The sulphur content in biomass varies in the range of 0.01–2.3,²² which is lower than that in coal.¹⁴⁷ The sulphur problem for BCLPs may be less severe compared to coal chemical looping. However, if the sulphur content in the biomass is still harmful to the LMs, a desulphuration process may be needed.

Ash. For the utilisation of biomass, especially sewage sludge, the effect of ash on the performance of the OC is crucial. Although OC particles are separable from fuel ash owing to the differences in their density and size, ash deposition cannot be ignored. Ash with a large content of high melting point Ca shows no agglomeration or sintering problems,^{59,148} but low melting point Na or K can promote agglomeration.^{148,149} The presence of Ca or Fe can lead to a positive effect on OC capacity owing to their ability to serve as OCs.¹⁵⁰ Gu *et al.* investigated the interaction between biomass ash and an iron ore oxygen carrier during BCLC.¹⁵¹ Three typical biomass ashes, named C ash (corn stalk ash), R ash (rate stalk ash) and W ash (wheat straw ash) were used as examples. Based on the classification in Fig. 3, C and R ash are low acid ash with K₂O and/or CaO as major components, whereas W ash is a high acid ash with 56.6% of SiO₂.²² The researchers observed that the addition of 15% of C ash or R ash (low acid ash) enhanced both fuel conversion and CO₂ capture efficiency over 10 cycles, whereas the W ash (high-acid) ash suppressed the fuel conversion and CO₂ capture efficiency. SEM and XRD results demonstrated that the SiO₂-rich ash produced potassium silicates, which led to serious particle sintering.¹⁵¹ For K-rich ash, the formation of K-Fe-O could weaken the Fe-O bond resulting in the easier release of lattice O from oxygen carriers.

Calcination. For BCaLG, one of the biggest issues is the deactivation of CaO after calcination. Acharya *et al.*, utilised a regeneration percentage of CaO of 40% at 800 °C,¹⁰⁰ which was not high enough for a continuous reaction. Feeding fresh CaO continuously was found to make the process uneconomical, since it required novel sorbents with lower deactivation rates.

5.2. Fouling due to unique biomass chemistry

Tar formation. Tar plugs reactor systems, which reduces efficiency, but there has been little investigation in on its effect in BCLPs. A minimum temperature of 1250 °C for 0.5 seconds can thermally crack tars efficiently, but at a cost of higher energy input.⁵¹ Additionally, a high LM/biomass ratio reduces tar. Metals, especially Ni are helpful for tar removal *via* cracking or reforming,¹⁵² with steam addition also assisting tar reforming.¹⁵³ For the calcium looping gasification (CaLG) process, tar formation is inhibited because of the active CaO.¹⁰⁹ Studies using iron-based oxygen carriers in a moving bed reactor have shown that these oxygen carriers can crack tar at high temperatures (900 °C).¹⁵⁴ Similar studies have shown that volatile biomass tars are effectively cracked over both oxidised and reduced Fe-based carriers (both supported and unsupported). Carbon deposition was found to be reversible and not to affect the cycling behaviour,¹⁵⁵ although it unfavourably affects the carbon capture by transferring carbon to the air reactor.



Biomass ash melting. Compared to coal, the ash melting point of biomass is much lower because of higher fractions of alkali metals such as potassium in the feedstock.³⁹ Therefore, ash (including volatile recondensing species) is a major challenge for BCLPs, which potentially causes fouling or corrosion within the reactor.¹⁵⁶ The American Society for Testing and Materials (ASTM) recommends operating temperature between 580 °C and 600 °C to prevent ash melting.¹⁵⁷ Most CLPs have a much higher temperature and 900 °C is recommended as the optimal operating temperature for BCLCs.^{11,12}

Ash with a low melting point remaining in the fuel reactor can cause agglomeration and even defluidisation.^{59,60,77} By continuous removal of alkali metal laden bed particles from the system, a quasi-steady state of stable operation could be achieved by keeping the alkali metal content of the carrier particles below a critical level for stickiness and consequent agglomeration and breakdown of fluidisation. This suggested method of operation, which sacrifices the carrier material due to the withdrawal of alkali metals from the system, requires a low cost carrier such as ilmenite and excludes the more expensive specially designed oxygen carriers.

Fouling and corrosion. In the case of BCLPs, surface corrosion issues in the air reactor are minimised compared to those in a conventional biomass fuelled furnace since most of the alkali metals are released and converted in the fuel reactor.^{59,60} The alkali metals remaining in the ash can be carried out of the system with the fly ash from the fuel reactor. BCLP allows most of the fly ash to elutriate from the fuel reactor owing to the big difference in the density of the carrier particles and ash. This may allow biomass fly ash recovery, which could be used for fertilizer due to the high content of nutrients, although sufficient separation between ash and fine bed carriers is required.

5.3. System complexity and scale

Pretreatment of biomass. Owing to the high moisture content, low energy density, and geometrical shape of biomass fuel, pretreatment, including drying and pelletising/pulverising is usually required.³⁹ Drying is an important pre-requisite for BCLCs because moisture in the feedstock decreases the temperature of the reactor. According to Li and Fan,¹¹ high-moisture biomass leads to a higher energy demand and lower OC conversion rate (<5% moisture is ideal). Pelletising/pulverising is necessary depending on the original form of the biomass. The increase in energy density is beneficial not only for BCLPs, but also for transportation and storage. In summary, biomass drying and comminution are energy intensive processes that cost significant energy compared to other solid fuels. For instance, drying 1 kg wood from 50% moisture to 20% moisture requires 2.03 MJ energy and pulverising 1 kg dry wood to less than 100 µm requires 2.27 MJ energy.¹³ To save the energy cost of drying, the waste heat from the BCLCs may be recovered and utilised. However, this depends on the elaborate system design and the addition of heat exchangers, which increases cost and complexity.

High solid recirculation rate. The solid recirculation rate is critical for chemical looping reactors. One challenge of CLPs is the high solid recirculation rate of looping materials. There are

few studies on the solid recirculation rate of biomass-based chemical looping, but the recirculation rate is expected to be higher since some biomass ash is cycled together with the LMs. The high solid recirculation rate increases the energy cost for the recirculation and gas–solid separation. In addition, a high solid recirculation rate will increase the size of the chemical looping reactor.

A higher O₂/CO₂ carrying capacity will reduce the required circulation rate. The carrying capacity depends on both the property of the reactive component and the extent of support. The effective carrying capacity could be influenced by the gas and solid residence time.¹⁷

Separation of biomass ash and LMs. Separation of LMs from biomass ash (including unreacted carbon) is also a problem for *in situ* reactions.⁹⁷ The efficiency of this separation has not been studied to a great extent. Additionally, interactions between biomass ash and LMs may reduce separation efficiency.

Small-scale applications. Similar to other heat-to-electricity processes, the BCLC system efficiency increases with an increase in unit capacity, where an increase in the net heat extraction and decrease in the net surface area to volume reduce the net heat loss. Li *et al.* calculated the efficiency of a BCLC plant to be 38% at a capacity of 100 MW and only 32% at 15 MW.¹¹ However, owing to the low energy density of biomass, and consequent requirements for biomass to be transported from a smaller geographical region surrounding the plant, biomass plants are usually smaller in size than fossil fuels plants.¹⁵⁸ In addition, the collection and transportation of biomass is an issue if the plant capacity is too big.¹⁵⁹ Therefore, the miniaturisation of BCLC processes with minimal loss of efficiency is an opportunity. An Organic Rankine Cycle (ORC) has a higher cycle efficiency for a small power plant with low temperatures and may be suitable for BCLCs.¹⁶⁰

System complexity. Most chemical looping processes operate at temperatures > 800 °C, although some require temperatures > 1000 °C, thus, practical operation can be problematic. Also, some CaLG processes operate at high pressures,⁹⁸ which adds to the existing operational complexity. Additionally, multiple heat exchangers are required, increasing both cost and complexity.

5.4. Techno-economic evaluations

Currently, very few techno-economic evaluations of BCLPs are available in the open literature, but all of these studies demonstrated the reduced energy penalty of CLPs compared to other conventional processes combined with carbon capture units.

Li simulated a BCLC plant using the Aspen Plus software.¹¹ The system had a maximised efficiency of 38.1% with a CO₂ capture efficiency of 99%. The electricity cost of BCLC was \$95 per MW h, which was much lower than that of an integrated biomass gasification combined cycle, but still higher than the oxy-coal-combustion process with carbon capture (\$66 per MW h).¹⁶¹ Recently, one new development has been the open release of the results from the UK's Energy Technologies Institute TESBIC programme.²¹ This project assessed the current technology readiness levels of BCLC as part of an overall assessment of 28 different combinations of CCS technology with biomass



combustion or gasification, with co-firing also studied. Chemical looping was demonstrated to be highly valuable as a potential technology, and was one of the 8 technologies shortlisted for detailed modelling. The modelling produced process flow diagrams for each technology and compared chemical looping with combustion with amine scrubbing (both co-fired and dedicated biomass combustion), oxyfuel (co-fired and dedicated biomass combustion), co-fired carbonate looping, co-fired IGCC and dedicated biomass IGCC. Potential issues were identified for each technology, which for BCLC were potential loss in reactivity of the OCs and the complexity of the dual bed operation. Importantly, relative to other technologies, BCLC was ranked as having a low capital cost when capture was added as well as good efficiency. It was noted in the study that it is challenging to compare technologies at a high level of technology readiness with that at a lower level. The overall findings of the study indicated that given the range of uncertainty in capital costs it is unwise to pick a favourite technology for long-term exploitation, but that continued research and development of BCLC is certainly justified. Thus, a further study was commissioned to reduce the overall error bounds for high temperature solid looping technologies.

Aghabararnejad *et al.*¹⁶² compared BCLG to conventional biomass gasification with air and found that BCLG can produce reformer gas with a higher calorific value. The use of steam can enhance the purity of H₂, however, steam gasification is endothermic. For comparison, a conventional gasification unit with pure oxygen (CGPO) and a BCLG system were modelled with Aspen Plus in a separate study.¹⁶² A 7 MW_{th} BCLG unit was simulated to treat biomass (86 t d⁻¹). A bubbling-bed gasifier (fuel reactor) and a fast fluidised bed oxidiser (air reactor) were designed for the study. Co₃O₄(8%)/Al₂O₃ (44.6 kg s⁻¹ circulation rate) was selected as the OC. The total capital investment of the BCLG unit was \$3.4 M higher than that of the CGPO, whereas annual production costs of the CGPO and CLG units were found to be \$1.9 M and \$1.32 M, respectively. The main difference between the operating costs of the units is due to the cost of raw materials. The pure O₂ supply contributes most to the overall operating costs for CGPO. On the other hand, the OCs can be recycled due to their long lifetimes, which reduces replacement costs.

A techno-economic evaluation of H₂ (up to 200 MW_{th}) and power (400–500 MW_e) co-generation from a sawdust-fired BCCLP (with an ilmenite OC) was also conducted.⁸⁸ The BCCLP concept was compared to various benchmark cases with or without carbon capture. Selexol[®]-based gas-liquid absorption and syngas chemical looping were selected as the benchmark cases for carbon capture and their energy penalty was found to be 9.2 and 8 net electricity percentage points, respectively, in comparison to 3.5% for BCCLP. The operational and maintenance cost of BCCLP is higher than the benchmark cases, which is mainly due to the cost incurred for regenerating OCs. However, the cost of electricity of BCCLP is lower than gas-liquid design (about 3.7%) and higher than the syngas-based chemical looping case (5.7%). Chemical looping not only achieves a higher energy efficiency (~42% net efficiency) but also nearly complete CO₂

capture (>99%). Moreover, the overall plant energy efficiency (power + hydrogen output) can be increased by 7 net efficiency points when the hydrogen output is 200 MW_{th}.

The application of CaO-based CaLG using coal can be traced back to the 1970s, where it was tested successfully in a pilot plant and proved to be economically feasible.⁹⁸ However, BCaLG using biomass took a lot longer to be trialled. BCaLG based on CaO on the scale of 100 kW, 120 kW, and 8 MW was reported in 2009.^{108,109} In the 100 kW and 120 kW tests, the concentration of H₂ in the produced gas was as high as 75%. Also, the 8 MW test proved the larger-scale viability of this idea.^{108,109}

6. Conclusions and perspectives

Biomass is an important energy source and its further development will lessen our dependence on fossil fuels. Considering its carbon-neutral nature, significant environmental benefits are expected, since the world is seeking clean, renewable energy solutions to reduce net GHG emissions. However, owing to its low energy density, high moisture content, complex ash composition and highly distributed resource, biomass is often less favoured in conventional thermochemical processes compared to fossil fuels. Conventional energy conversion systems are generally not directly integrated with CO₂ capture. Therefore, the search for a conversion system that can provide high efficiency, product flexibility (ranging from electricity to chemicals), *in situ* carbon capture, and scalability (small to large) has been intense. As discussed in this review, biomass-based chemical looping technologies have gained significant attention and have great potential to provide a sustainable pathway towards decarbonised energy and materials production.

How to get there? The good, the bad, and the future of biomass-based CLPs includes:

The good: biomass-based chemical looping is promising due to its low exergy loss and capacity for inherent CO₂ separation. When biomass is directly used in chemical looping, no additional energy is required for CO₂ capture (energy is only required for compression for transport), the overall exergy loss is minimised, and if combined with appropriate carbon storage, a net negative carbon balance can be achieved. Moreover, the relatively high quantity of volatile matter, and low sulphur and ash content of biomass will improve the operation of a chemical looping process compared to coal utilisation. Some looping materials allow chemical looping oxygen uncoupling (CLOU) to be realised with consequently faster biomass conversion rates. Instead of heat or power, syngas, hydrogen or even carbon-based chemicals can be produced through biomass-based chemical looping gasification (CLG) or calcium looping gasification (CaLG). This flexibility in product type distinguishes biomass-based chemical looping processes (BCLPs) from other renewable energy sources such as solar or wind. A number of studies have already demonstrated the recyclability of looping materials and recent techno-economic assessments suggest a net reduction in energy penalty. Thus, biomass-based chemical looping has significant potential to offer



a sustainable and efficient pathway to utilise biomass resources in an efficient manner, coupled with the potential to effectively remove CO₂ (net) from the atmosphere.

The bad: although biomass-based chemical looping processes have many advantages compared to traditional biomass utilisation methods, they also share some challenges such as looping material deactivation, high solid recirculation rate, and the requirement for separation of looping materials and biomass ash. Therefore, significant efforts are currently devoted to solve these problems for the ultimate goal of commercializing this technology. Continuous efforts are in progress to determine the details of its reaction mechanisms, kinetics, mass transfer and other operational challenges. Once these have been identified and fully addressed, further overall systems integration studies are required to minimise exergy loss within the overall system, while improving the economics and environmental sustainability of the developed technology.

The future: similarly to many other disruptive technologies, the large-scale implementation of biomass-based chemical looping technologies will not be easy, but the potential gain should outweigh the challenge. There are a number of pilot-scale demonstrations of chemical looping processes, which will be important bases for the future of biomass-based chemical looping processes. Despite the fact that results in pilots may not be directly translatable to commercial-sized units, the understanding, experience, and know-how gained from fundamental and small-scale research will be central for the development of biomass-based chemical looping technologies.

Some future thoughts/perspectives on BCLPs are as follows:

(a) Development of biomass gasification processes for syngas generation and chemicals/liquid fuels production should focus on process intensification.¹⁶³ Process intensification should allow for the conversion of biomass to high quality syngas with an appropriate H₂:CO ratio in a single step without the use of molecular oxygen and capital-intensive units including tar reformer, water gas shift reactors, and air separation units. Such high-quality syngas generation would permit downstream processing to produce chemicals/liquid fuels without requiring syngas re-conditioning while reducing the capital and operating costs associated with acid gas (CO₂ and sulphur) removal.

(b) Holistic evaluation of the system operating pressure is crucial for ensuring the cost-competitiveness of biomass-based chemical looping systems. A higher operating pressure increases the local concentration of the reactants on the LM, thereby enhancing the kinetics of biomass conversion. This helps to reduce the reactor size and compression costs associated with the syngas product while increasing the cost of construction materials and re-oxidation air compression costs. Optimization of operating pressures for chemical looping reactors using multi-phase flow reactor engineering and techno-economic considerations and corresponding pilot scale experimental verification is necessary.

(c) Research towards the enhancement of the multifunctional nature of LM, while sustaining reactivity and structural integrity for thousands of redox cycles is crucial. An example of multifunctional enhancement is the development of an LM that can

gasify biomass char and crack biomass tar to syngas in a single reactor using new dopants and support materials. The rationale for the choice of dopants and support materials for LM should be driven by a deep scientific understanding of material properties which is derived using tools such as DFT/molecular modelling aided by experimental verification. The developed multifunctional LMs should be screened for their lifecycle based impact and cost of production.

(d) Linkage of industrial processes with BCLP, most likely *via* BCLC, BCLG, and bottom-up redesign of current “state of the art” processes. For example, there is significant synergy between Ca-looping and cement manufacturing. Collaboration between the power and chemical industries for pilot scale demonstrations will greatly benefit the commercialization of BCLP.

(e) In addition to screening for holistic economic advantages for one specific biomass feedstock, operational flexibility in the variation of feedstock composition is required. This versatility would allow for fast response to the changes in supply and demand of the feedstock market.

(f) BCLP is also a potential strategy to obtain energy from biomass waste (such as woody waste, municipal waste or dry sludge from wastewater treatment plants) with a net carbon negative balance. CO₂ utilization strategies, which have the potential to enhance syngas yields, should be implemented.¹⁶⁴ A focus on the economic conversion of biomass waste to high value chemical products and liquid fuels would accelerate the large-scale commercial deployment of BCLP.

Fundamental knowledge gained from these studies should be shared with those researching other biomass conversion and chemical looping technologies in order to accelerate the realisation of BECCS as a crucial technology in the continued fight against climate change.

Glossary

ASTM	American Society for Testing and Materials
BECCS	Bioenergy with carbon capture and storage
BCaLC	Biomass-based calcium looping combustion
BCaLG	Biomass-based calcium looping gasification
BCCLP	Biomass-based co-production chemical looping process
BCLC	Biomass-based chemical looping combustion
BCLG	Biomass-based chemical looping gasification
BCLP	Biomass-based chemical looping process
CCS	Carbon capture and storage
CC	CO ₂ carrier
CGPO	Conventional gasification unit with pure oxygen
CaLC	Calcium looping combustion
CaLG	Calcium looping gasification
CLC	Chemical looping combustion
CLG	Chemical looping gasification
CLOU	Chemical looping oxygen uncoupling
CLP	Chemical looping process
CLR	Chemical looping reforming
GHG	Greenhouse gas



IGCC	Integrated gasification combined cycle
iG-CLC	<i>In situ</i> gasification chemical looping combustion
IPCC	Intergovernmental panel on climate change
LHV	Low heating value
LM	Looping material
OC	Oxygen carrier
OU-BCLC	Oxygen uncoupling biomass-based CLC
OU-BCLG	Oxygen uncoupling biomass-based CLG
SE-BCLG	Sorption enhanced BCLG
SNG	Synthetic natural gas
TESBIC	Techno-economic study of biomass to power with integrated CO ₂ capture
PAH	Polycyclic aromatic hydrocarbon
TGA	Thermogravimetric analyser
UNFCCC	United Nations Framework Convention on Climate Change

Acknowledgements

This work was supported by the National Recruitment Program of Global Youth Experts (The National Youth 1000 – Talent Program) of China (grant number: 20151710227); Tsinghua University Initiative Scientific Research Program (grant number: 20161080094); United States National Science Foundation (CBET 1336567 and CBET 1231393). The helpful assistance of Arun K. Vuppaladadiyam for preparing Fig. 1 is gratefully acknowledged. PSF thanks the EPSRC for funding under grant number EP/P026214/1 (UK CCS Research Centre).

References

- S. Manabe and R. T. Wetherald, *J. Atmos. Sci.*, 1980, **37**, 99–118.
- A. Goepfert, M. Czaun, J.-P. Jones, G. S. Prakash and G. A. Olah, *Chem. Soc. Rev.*, 2014, **43**, 7995–8048.
- BP, BP Statistical Review of World Energy June 2016, <http://www.bp.com/en/global/corporate/energy-economics/statistical-review-of-world-energy.html>.
- CO₂ Emissions, The World Bank, 2016.
- J. Rogelj and R. Knutti, *Nat. Geosci.*, 2016, **9**, 187–189.
- J. Adanez, A. Abad, F. Garcia-Labiano, P. Gayan and F. Luis, *Prog. Energy Combust. Sci.*, 2012, **38**, 215–282.
- M. Zhao, A. I. Minett and A. T. Harris, *Energy Environ. Sci.*, 2013, **6**, 25–40.
- R. D. Perlack, L. M. Eaton, A. F. Turhollow Jr, M. H. Langholtz, C. C. Brandt, M. E. Downing, R. L. Graham, L. L. Wright, J. M. Kavkewitz and A. M. Shamey, *US billion-ton update: biomass supply for a bioenergy and bioproducts industry*, Oak Ridge National Lab, Oak Ridge, TN, 2011.
- P. Lamers, R. Hoefnagels, M. Junginger, C. Hamelinck and A. Faaij, *GCB Bioenergy*, 2015, **7**, 618–634.
- IPCC, Climate Change 2013: The Physical Science Basis: Working Group I Contribution to the Fifth Assessment Report of the Intergovernmental Panel on Climate Change, Cambridge University Press, New York, 2013, vol. 1.
- F. Li, L. Zeng and L.-S. Fan, *Fuel*, 2010, **89**, 3773–3784.
- N. Kobayashi and L.-S. Fan, *Biomass Bioenergy*, 2011, **35**, 1252–1262.
- M. S. Mettler, D. G. Vlachos and P. J. Dauenhauer, *Energy Environ. Sci.*, 2012, **5**, 7797–7809.
- L.-S. Fan, L. Zeng, W. Wang and S. Luo, *Energy Environ. Sci.*, 2012, **5**, 7254–7280.
- L.-S. Fan, L. Zeng and S. Luo, *AIChE J.*, 2015, **61**, 2–22.
- S. Luo, L. Zeng and L.-S. Fan, *Annu. Rev. Chem. Biomol. Eng.*, 2015, 53–75.
- L.-S. Fan, *Chemical Looping Systems for Fossil Fuel Conversions*, John Wiley and Sons, New York, 2010.
- E. R. Gilliland, *Production of industrial gas comprising carbon monoxide and hydrogen*, US Pat., 2671721, 1954.
- M. Ishida, D. Zheng and T. Akehata, *Energy*, 1987, **12**, 147–154.
- B. Moghtaderi, *Energy Fuels*, 2011, **26**, 15–40.
- A. Bhave, R. H. S. Taylor, P. Fennell, W. R. Livingston, N. Shah, N. M. Dowell, J. Dennis, M. Kraft, M. Pourkashanian, M. Insa, J. Jones, N. Burdett, A. Bauen, C. Beal, A. Smallbone and J. Akroyd, *Appl. Energy*, 2017, **190**, 481–489.
- S. V. Vassilev, D. Baxter, L. K. Andersen and C. G. Vassileva, *Fuel*, 2013, **105**, 40–76.
- S. V. Vassilev, D. Baxter, L. K. Andersen, C. G. Vassileva and T. J. Morgan, *Fuel*, 2012, **94**, 1–33.
- S. V. Vassilev, D. Baxter and C. G. Vassileva, *Fuel*, 2014, **117**, 152–183.
- M. Tang, L. Xu and M. Fan, *Appl. Energy*, 2015, **151**, 143–156.
- F. He, H. Li and Z. Zhao, *Int. J. Chem. Eng.*, 2009, **2009**, 710515, DOI: 10.1155/2009/710515.
- Q. Imtiaz, D. Hosseini and C. R. Müller, *Energy Technol.*, 2013, **1**, 633–647.
- P. Markström, C. Linderholm and A. Lyngfelt, *Int. J. Greenhouse Gas Control*, 2013, **15**, 150–162.
- A. Lyngfelt, *Appl. Energy*, 2014, **113**, 1869–1873.
- P. Basu, *Biomass gasification and pyrolysis: Practical design and theory*, Academic Press, 2010.
- D. Gera, *Biofuels and bioenergy*, *Encyclopedia of chemical processing*, CRC Press, 2005.
- I. E. A. (IEA), *Technology Roadmap Bioenergy for Heat and Power*, 2012.
- A. Demirbas, *Energy Sources*, 2006, **28**, 779–792.
- R. Luque, *Energy Environ. Sci.*, 2010, **3**, 254–257.
- H. Tadesse and R. Luque, *Energy Environ. Sci.*, 2011, **4**, 3913–3929.
- P. Sannigrahi, A. J. Ragauskas and G. A. Tuskan, *Biofuels, Bioprod. Biorefin.*, 2010, **4**, 209–226.
- D. Shen and S. Gu, *Bioresour. Technol.*, 2009, **100**, 6496–6504.
- R. Rinaldi and F. Schüth, *Energy Environ. Sci.*, 2009, **2**, 610–626.
- P. McKendry, *Bioresour. Technol.*, 2002, **83**, 37–46.
- S. V. Vassilev, C. G. Vassileva and V. S. Vassilev, *Fuel*, 2015, **158**, 330–350.
- S. V. Vassilev, D. Baxter, L. K. Andersen and C. G. Vassileva, *Fuel*, 2010, **89**, 913–933.
- C. Linderholm and A. Lyngfelt, Chemical-looping combustion of solid fuels, in *Calcium and Chemical Looping Technology for*



- Power Generation and Carbon Dioxide (CO₂) Capture*, ed. P. Fennell and B. Anthony, 2015, ch. 14, pp. 299–326.
- 43 D. Das and T. N. Veziroğlu, *Int. J. Hydrogen Energy*, 2001, **26**, 13–28.
- 44 E. Kirtay, *Energy Convers. Manage.*, 2011, **52**, 1778–1789.
- 45 W. Gerbens-Leenes, A. Y. Hoekstra and T. H. van der Meer, *Proc. Natl. Acad. Sci. U. S. A.*, 2009, **106**, 10219–10223.
- 46 USDOE, *Post-combustion carbon capture research*, <https://energy.gov/fe/science-innovation/carbon-capture-and-storage-research/carbon-capture-rd/post-combustion-carbon>, Department Of Energy, 2012.
- 47 A. Nandy, C. Loha, S. Gu, P. Sarkar, M. K. Karmakar and P. K. Chatterjee, *Renewable Sustainable Energy Rev.*, 2016, **59**, 597–619.
- 48 T. Nussbaumer, *Energy Fuels*, 2003, **17**, 1510–1521.
- 49 B. Jenkins, L. Baxter and T. Miles, *Fuel Process. Technol.*, 1998, **54**, 17–46.
- 50 Y. Niu, H. Tan and S. e. Hui, *Prog. Energy Combust. Sci.*, 2016, **52**, 1–61.
- 51 J. Han and H. Kim, *Renewable Sustainable Energy Rev.*, 2008, **12**, 397–416.
- 52 H. Leion, T. Mattisson and A. Lyngfelt, *CO₂ capture from direct combustion of solid fuels with chemical-looping combustion*, *The Proceedings of the 33rd International Technical Conference on Coal Utilization & Fuel Systems*, 2008.
- 53 L. Shen, J. Wu, J. Xiao, Q. Song and R. Xiao, *Energy Fuels*, 2009, **23**, 2498–2505.
- 54 Y. Cao and W.-P. Pan, *Energy Fuels*, 2006, **20**, 1836–1844.
- 55 T. J. Kotas, *The Exergy Method of Thermal Plant Analysis*, Butterworth Publishers, London, UK, 1985.
- 56 T. Mattisson, M. Johansson and A. Lyngfelt, *CO₂ capture from coal combustion using chemical-looping combustion—reactivity investigation of Fe, Ni and Mn based oxygen carriers using syngas*, *Proceedings of the Clearwater Coal Conference*, 2006.
- 57 T. Mattisson, A. Lyngfelt and H. Leion, *Int. J. Greenhouse Gas Control*, 2009, **3**, 11–19.
- 58 T. Mendiara, A. Abad, L. de Diego, F. García-Labiano, P. Gayán and J. Adánez, *Int. J. Greenhouse Gas Control*, 2013, **19**, 322–330.
- 59 X. Niu, L. Shen, H. Gu, S. Jiang and J. Xiao, *Chem. Eng. J.*, 2015, **268**, 236–244.
- 60 X. Niu, L. Shen, H. Gu, T. Song and J. Xiao, *Chem. Eng. J.*, 2015, **260**, 631–641.
- 61 A. Sarvaramini and F. Larachi, *Fuel*, 2014, **116**, 158–167.
- 62 A. Sarvaramini and F. Larachi, *Energy Fuels*, 2014, **28**, 1983–1991.
- 63 R. J. Evans and T. A. Milne, *Energy Fuels*, 1987, **1**, 311–319.
- 64 A. Cuadrat, A. Abad, F. García-Labiano, P. Gayán, L. De Diego and J. Adánez, *Int. J. Greenhouse Gas Control*, 2011, **5**, 1630–1642.
- 65 A. Lyngfelt and T. Mattisson, *Trestegsfo rbranning for avskiljning av koldioxid*, *Swedish Pat.*, SE 0500249-8, 2005.
- 66 I. Adánez-Rubio, A. Abad, P. Gayán, L. De Diego, F. García-Labiano and J. Adánez, *Fuel Process. Technol.*, 2014, **124**, 104–114.
- 67 T. Mendiara, I. Adánez-Rubio, P. Gayán, A. Abad, L. de Diego, F. García-Labiano and J. Adánez, *Energy Technol.*, 2016, **4**, 1130–1136.
- 68 A. Corcoran, J. Marinkovic, F. Lind, H. Thunman, P. Knutsson and M. Seemann, *Energy Fuels*, 2014, **28**, 7672–7679.
- 69 H. Thunman, F. Lind, C. Breitholtz, N. Berguerand and M. Seemann, *Fuel*, 2013, **113**, 300–309.
- 70 H. Gu, L. Shen, J. Xiao, S. Zhang and T. Song, *Energy Fuels*, 2011, **25**, 446–455.
- 71 G. Wei, F. He, Z. Huang, A. Zheng, K. Zhao and H. Li, *Energy Fuels*, 2015, **29**, 233–241.
- 72 S. Huseyin, G.-q. Wei, H.-b. Li, H. Fang and Z. Huang, *J. Fuel Chem. Technol.*, 2014, **42**, 922–931.
- 73 M. Virginie, J. Adánez, C. Courson, L. De Diego, F. García-Labiano, D. Niznansky, A. Kiennemann, P. Gayán and A. Abad, *Appl. Catal., B*, 2012, **121**, 214–222.
- 74 Z. Huang, F. He, Y. Feng, R. Liu, K. Zhao, A. Zheng, S. Chang, Z. Zhao and H. Li, *Int. J. Hydrogen Energy*, 2013, **38**, 14568–14575.
- 75 Z. Huang, F. He, Y. Feng, K. Zhao, A. Zheng, S. Chang and H. Li, *Bioresour. Technol.*, 2013, **140**, 138–145.
- 76 Z. Huang, F. He, K. Zhao, Y. Feng, A. Zheng, S. Chang, Z. Zhao and H. Li, *J. Therm. Anal. Calorim.*, 2014, **116**, 1315–1324.
- 77 H. Ge, W. Guo, L. Shen, T. Song and J. Xiao, *Chem. Eng. J.*, 2016, **286**, 174–183.
- 78 F. García-Labiano, E. García-Díez, L. De Diego, A. Serrano, A. Abad, P. Gayán, J. Adánez and J. Ruíz, *Fuel Process. Technol.*, 2015, **137**, 24–30.
- 79 A. Lea-Langton, R. M. Zin, V. Dupont and M. V. Twigg, *Int. J. Hydrogen Energy*, 2012, **37**, 2037–2043.
- 80 G. Huijun, S. Laihong, F. Fei and J. Shouxi, *Appl. Therm. Eng.*, 2015, **85**, 52–60.
- 81 L. Guo, H. Zhao and C. Zheng, *Waste Biomass Valorization*, 2015, **6**, 81–89.
- 82 G. Wei, F. He, Z. Zhao, Z. Huang, A. Zheng, K. Zhao and H. Li, *Int. J. Hydrogen Energy*, 2015, **40**, 16021–16032.
- 83 J. Ran, F. Fu, C. Qin, P. Zhang, L. Yang, W. Wang and L. Yang, *BioResources*, 2016, **11**, 2109–2123.
- 84 H. Zhao, L. Guo and X. Zou, *Appl. Energy*, 2015, **157**, 408–415.
- 85 Z. Huang, F. He, H. Zhu, D. Chen, K. Zhao, G. Wei, Y. Feng, A. Zheng, Z. Zhao and H. Li, *Appl. Energy*, 2015, **157**, 546–553.
- 86 Z. Huang, Y. Zhang, J. Fu, L. Yu, M. Chen, S. Liu, F. He, D. Chen, G. Wei, K. Zhao, A. Zheng, Z. Zhao and H. Li, *Int. J. Hydrogen Energy*, 2016, **41**, 17871–17883.
- 87 H. Ge, W. Guo, L. Shen, T. Song and J. Xiao, *Chem. Eng. J.*, 2016, **286**, 689–700.
- 88 C.-C. Cormos, *Fuel Process. Technol.*, 2015, **137**, 16–23.
- 89 S. G. Gopaul, A. Dutta and R. Clemmer, *Int. J. Hydrogen Energy*, 2014, **39**, 5804–5817.
- 90 L. Yan, B. He, X. Pei, C. Wang, Z. Duan, J. Song and X. Li, *Int. J. Hydrogen Energy*, 2014, **39**, 17540–17553.
- 91 M. Rydén and M. Arjmand, *Int. J. Hydrogen Energy*, 2012, **37**, 4843–4854.
- 92 J. C. Abanades, M. n. Alonso and N. Rodríguez, *Ind. Eng. Chem. Res.*, 2011, **50**, 6972–6981.
- 93 M. N. Alonso, N. Rodríguez, B. N. González, B. Arias and J. C. Abanades, *Ind. Eng. Chem. Res.*, 2011, **50**, 6982–6989.



- 94 M. Alonso, M. Diego, C. Pérez, J. Chamberlain and J. Abanades, *Int. J. Greenhouse Gas Control*, 2014, **29**, 142–152.
- 95 D. C. Ozcan, M. n. Alonso, H. Ahn, J. C. Abanades and S. Brandani, *Ind. Eng. Chem. Res.*, 2014, **53**, 10721–10733.
- 96 M. R. Stonor, T. E. Ferguson, J. G. Chen and A.-H. A. Park, *Energy Environ. Sci.*, 2015, **8**, 1702–1706.
- 97 F. Yin, K. Shah, C. Zhou, P. Tremain, J. Yu, E. Doroodchi and B. Moghtaderi, *Energy Fuels*, 2016, **30**, 1730–1740.
- 98 J. Udomsirichakorn and P. A. Salam, *Renewable Sustainable Energy Rev.*, 2014, **30**, 565–579.
- 99 B. Moghtaderi, J. Zanganeh, K. Shah and H. Wu, *Energy Fuels*, 2012, **26**, 2046–2057.
- 100 B. Acharya, A. Dutta and P. Basu, *Energy Fuels*, 2009, **23**, 5077–5083.
- 101 H. Gu, G. Song, J. Xiao, H. Zhao and L. Shen, *Energy Fuels*, 2013, **27**, 4695–4704.
- 102 L. Wei, S. Xu, J. Liu, C. Liu and S. Liu, *Energy Fuels*, 2008, **22**, 1997–2004.
- 103 B. Dou, Y. Song, C. Wang, H. Chen, M. Yang and Y. Xu, *Appl. Energy*, 2014, **130**, 342–349.
- 104 P. Pimenidou, G. Rickett, V. Dupont and M. Twigg, *Bioresour. Technol.*, 2010, **101**, 6389–6397.
- 105 P. Pimenidou, G. Rickett, V. Dupont and M. V. Twigg, *Bioresour. Technol.*, 2010, **101**, 9279–9286.
- 106 T. Udomchoke, S. Wongsakulphasatch, W. Kiatkittipong, A. Arpornwichanop, W. Khaodee, J. Powell, J. Gong and S. Assabumrungrat, *Chem. Eng. J.*, 2016, **303**, 338–347.
- 107 J. Udomsirichakorn, P. Basu, P. A. Salam and B. Acharya, *Fuel Process. Technol.*, 2014, **127**, 7–12.
- 108 S. Koppatz, C. Pfeifer, R. Rauch, H. Hofbauer, T. Marquard-Moellenstedt and M. Specht, *Fuel Process. Technol.*, 2009, **90**, 914–921.
- 109 G. Soukup, C. Pfeifer, A. Kreuzeder and H. Hofbauer, *Chem. Eng. Technol.*, 2009, **32**, 348–354.
- 110 L. F. de Diego, M. Ortiz, F. García-Labiano, J. Adánez, A. Abad and P. Gayán, *J. Power Sources*, 2009, **192**, 27–34.
- 111 A. Lyngfelt, P. Fennell and B. Anthony, *Calcium and Chemical Looping Technology for Power Generation and Carbon Dioxide (CO₂) Capture*, 2015, pp. 221–254.
- 112 J. Adánez, C. Dueso, L. F. de Diego, F. García-Labiano, P. Gayán and A. Abad, *Ind. Eng. Chem. Res.*, 2009, **48**, 2509–2518.
- 113 A. Lyngfelt, *Oil Gas Sci. Technol.*, 2011, **66**, 161–172.
- 114 M. Ishida and H. Jin, *J. Chem. Eng. Jpn.*, 1994, **27**, 296–301.
- 115 F. García-Labiano, L. F. de Diego, P. Gayán, J. Adánez, A. Abad and C. Dueso, *Ind. Eng. Chem. Res.*, 2009, **48**, 2499–2508.
- 116 J. Adanez, L. F. de Diego, F. García-Labiano, P. Gayán, A. Abad and J. Palacios, *Energy Fuels*, 2004, **18**, 371–377.
- 117 A. Abad, J. Adánez, F. García-Labiano, F. Luis, P. Gayán and J. Celaya, *Chem. Eng. Sci.*, 2007, **62**, 533–549.
- 118 P. Cho, T. Mattisson and A. Lyngfelt, *Ind. Eng. Chem. Res.*, 2005, **44**, 668–676.
- 119 E. Jerndal, T. Mattisson and A. Lyngfelt, *Chem. Eng. Res. Des.*, 2006, **84**, 795–806.
- 120 M. Rydén, E. Cleverstam, M. Johansson, A. Lyngfelt and T. Mattisson, *AIChE J.*, 2010, **56**, 2211–2220.
- 121 C. Forero, P. Gayán, F. García-Labiano, L. De Diego, A. Abad and J. Adánez, *Int. J. Greenhouse Gas Control*, 2010, **4**, 762–770.
- 122 S. Chuang, J. Dennis, A. Hayhurst and S. Scott, *Combust. Flame*, 2008, **154**, 109–121.
- 123 Q. Zafar, T. Mattisson and B. Gevert, *Energy Fuels*, 2006, **20**, 34–44.
- 124 H. Tian, T. Simonyi, J. Poston and R. Siriwardane, *Ind. Eng. Chem. Res.*, 2009, **48**, 8418–8430.
- 125 M. Johansson, T. Mattisson and A. Lyngfelt, *Chem. Eng. Res. Des.*, 2006, **84**, 807–818.
- 126 H. Jin, T. Okamoto and M. Ishida, *Energy Fuels*, 1998, **12**, 1272–1277.
- 127 T. Mattisson, A. Järndnäs and A. Lyngfelt, *Energy Fuels*, 2003, **17**, 643–651.
- 128 K. Salazar and M. K. McNutt, *Mineral commodity summaries*, US Geological Survey, Reston, VA, 2012.
- 129 I. Adanez-Rubio, P. Gayán, F. García-Labiano, F. Luis, J. Adánez and A. Abad, *Energy Procedia*, 2011, **4**, 417–424.
- 130 A. Shulman, E. Cleverstam, T. Mattisson and A. Lyngfelt, *Energy Fuels*, 2009, **23**, 5269–5275.
- 131 M. Rydén, A. Lyngfelt and T. Mattisson, *Energy Procedia*, 2011, **4**, 341–348.
- 132 H. Leion, Y. Larring, E. Bakken, R. Bredesen, T. Mattisson and A. Lyngfelt, *Energy Fuels*, 2009, **23**, 5276–5283.
- 133 L. Han, Q. Wang, Y. Yang, C. Yu, M. Fang and Z. Luo, *Int. J. Hydrogen Energy*, 2011, **36**, 4820–4829.
- 134 J. Wang, V. Manovic, Y. Wu and E. J. Anthony, *Appl. Energy*, 2010, **87**, 1453–1458.
- 135 P. Sun, J. Grace, C. Lim and E. Anthony, *AIChE J.*, 2007, **53**, 2432–2442.
- 136 F. Donat, N. H. Florin, E. J. Anthony and P. S. Fennell, *Environ. Sci. Technol.*, 2012, **46**, 1262–1269.
- 137 V. Nikulshina, M. E. Gálvez and A. Steinfield, *Chem. Eng. J.*, 2007, **129**, 75–83.
- 138 D. Y. Lu, R. W. Hughes and E. J. Anthony, *Fuel Process. Technol.*, 2008, **89**, 1386–1395.
- 139 Y. Li, C. Zhao, Q. Ren, L. Duan, H. Chen and X. Chen, *Fuel Process. Technol.*, 2009, **90**, 825–834.
- 140 T. Mattisson, M. Johansson and A. Lyngfelt, *Fuel*, 2006, **85**, 736–747.
- 141 P. Cho, T. Mattisson and A. Lyngfelt, *Fuel*, 2004, **83**, 1215–1225.
- 142 T. Mattisson, M. Johansson, E. Jerndal and A. Lyngfelt, *Can. J. Chem. Eng.*, 2008, **86**, 756–767.
- 143 P. Gayán, F. Luis, F. García-Labiano, J. Adánez, A. Abad and C. Dueso, *Fuel*, 2008, **87**, 2641–2650.
- 144 P. Gayán, C. Dueso, A. Abad, J. Adanez, F. Luis and F. García-Labiano, *Fuel*, 2009, **88**, 1016–1023.
- 145 I. Iliuta, R. Tahoces, G. S. Patience, S. Riffart and F. Luck, *AIChE J.*, 2010, **56**, 1063–1079.
- 146 L. F. de Diego, P. Gayán, F. García-Labiano, J. Celaya, A. Abad and J. Adánez, *Energy Fuels*, 2005, **19**, 1850–1856.
- 147 W. H. Calkins, *Fuel*, 1994, **73**, 475–484.
- 148 M. Keller, M. Arjmand, H. Leion and T. Mattisson, *Chem. Eng. Res. Des.*, 2014, **92**, 1753–1770.
- 149 C.-L. Lin, J.-H. Kuo, M.-Y. Wey, S.-H. Chang and K.-S. Wang, *Powder Technol.*, 2009, **189**, 57–63.



- 150 M. M. Azis, H. Leion, E. Jerndal, B. M. Steenari, T. Mattisson and A. Lyngfelt, *Chem. Eng. Technol.*, 2013, **36**, 1460–1468.
- 151 H. Gu, L. Shen, Z. Zhong, Y. Zhou, W. Liu, X. Niu, H. Ge, S. Jiang and L. Wang, *Chem. Eng. J.*, 2015, **277**, 70–78.
- 152 C. Wu, L. Wang, P. T. Williams, J. Shi and J. Huang, *Appl. Catal., B*, 2011, **108**, 6–13.
- 153 T. Furusawa, Y. Miura, Y. Kori, M. Sato and N. Suzuki, *Catal. Commun.*, 2009, **10**, 552–556.
- 154 S. Luo, A. Majumder, E. Chung, D. Xu, S. Bayham, Z. Sun, L. Zeng and L.-S. Fan, *Ind. Eng. Chem. Res.*, 2013, **52**, 14116–14124.
- 155 E. B.-H. Matthew, F. Nick and S. F. Paul, *Environ. Res. Lett.*, 2016, **11**, 115001.
- 156 A. Demirbas, *Prog. Energy Combust. Sci.*, 2004, **30**, 219–230.
- 157 ASTM, *Standard test method for ash in wood*, D-1102-84 American Society for Testing and Materials, Philadelphia, PA, 2003.
- 158 R. Saidur, E. Abdelaziz, A. Demirbas, M. Hossain and S. Mekhilef, *Renewable Sustainable Energy Rev.*, 2011, **15**, 2262–2289.
- 159 A. A. Rentizelas, A. J. Tolis and I. P. Tatsiopoulos, *Renewable Sustainable Energy Rev.*, 2009, **13**, 887–894.
- 160 U. Drescher and D. Brüggemann, *Appl. Therm. Eng.*, 2007, **27**, 223–228.
- 161 J. S. Rhodes and D. W. Keith, *Biomass Bioenergy*, 2005, **29**, 440–450.
- 162 M. Aghabararnejad, G. S. Patience and J. Chaouki, *Chem. Eng. Technol.*, 2015, **38**, 867–878.
- 163 L.-S. Fan, *Chemical Looping Partial Oxidation Gasification: Reforming, and Chemical Syntheses*, Cambridge University Press, London, 2017.
- 164 M. Kathe, A. Empfield, P. Sandvik, C. Fryer, Y. Zhang, E. Blair and L.-S. Fan, *Energy Environ. Sci.*, 2017, DOI: 10.1039/C6EE03701A.

